

2024

Issue One



# Complete Lighting Guide 2024

Manufacturers of quality lighting since 1920



British Electric Lamps Ltd  
[www.bellighting.co.uk](http://www.bellighting.co.uk)



## Exterior Lighting

### Floodlights

Skyline Powertron	Page 22
Skyline Padel	Page 28
Skyline Elite+	Page 32
Skyline Elite+ High Output Asymmetric LED Floodlight	Page 36
Skyline Virtus Asymmetric/Symmetric LED Floodlight	Page 40
Skyline Slim+ LED Floodlight	Page 46
Skyline Cosmos LED Floodlight	Page 50
Skyline Mini LED Floodlight	Page 54

### Wallpack

Muro Wallpack	Page 58
Lumo Asymmetric Wallpack	Page 62

### Street Lights

Alto LED Street Light	Page 66
-----------------------	---------

### Garden Lights

Luna Outdoor Wall / Spike Garden Light IP65	Page 70
Luna Grande Outdoor Wall Light IP65	Page 76

### Lanterns

Retro Vintage Lantern	Page 80
-----------------------	---------



As part of our commitment to minimising impact on the environment, the paper used to produce this catalogue is from sustainable sources.

Reducing our carbon footprint is a priority and BELL make every effort to ensure our effect on the environment is as minimal as possible.





## Interior Lighting

### Warehouse Lighting

Illumina Atlas Switchable Wattage LED High Bay	Page 86
Illumina Slim Elite LED High Bay	Page 90
Illumina Muto Switchable Wattage LED High/Low Bay	Page 94
Illumina Calor LED High Bay	Page 98
Illumina Linear High Intensity LED High/Low Bay	Page 102
Illumina Linear High Intensity UGR <20 LED High Bay	Page 106

### Battens

Dura LED Integrated Anti Corrosive Batten	Page 110
Dura LED Integrated CCT Anti Corrosive Batten	Page 116
Mentor LED Integrated CCT UGR <19 Batten	Page 120
Ultra LED Integrated Batten	Page 124
Ultra LED CCT Integrated Batten	Page 130
Ultra Slim LED Integrated Batten	Page 134

### Bulkheads

Aqua1 LED CCT Wattage Switchable Bulkhead	Page 138
Universal Wattage Switchable LED Gear Tray	Page 142
Deco Slim LED CCT Bulkhead	Page 144
Deco Grande LED Bulkhead	Page 150



## Panels

Arial LED Round Panel	Page 154
Arial LED Converter/Large Converter	Page 160
Arial Pro LED CCT Downlight	Page 164
Arial Plus Multi Backlit High Output UGR <19 LED Panel	Page 168
Arial Multi Backlit LED Panel	Page 174
Arial Multi IP65 Backlit LED Panel	Page 178
Arial T-Pro Multi Troffer Backlit LED CCT Panel	Page 182

## Downlights

Firestay Integrated LED CCT Fixed/Centre Tilt Downlight	Page 186
Firestay Primo Integrated LED Fixed Downlight	Page 190
Firestay Duo Integrated LED Fixed/ Centre Tilt Downlight	Page 194
Firestay Geo® LED Sustainable Modular Downlight	Page 198
Firestay LED Anti-Glare CCT Fixed Downlight	Page 202
Firestay LED Anti-Glare CCT Centre Tilt Downlight	Page 208
Firestay LED Integrated Fixed Downlight	Page 212
Firestay Slim Integrated LED Fixed/Centre Tilt Downlight	Page 216
Firestay Guardian Non Integrated Downlight	Page 220
Firestay Protector	Page 224



## Accessories

### Connectors

Quick Fix Connector - 3/4 Pole Page 230

### Drivers

LED Driver Page 232

### Dimmers

Smart Universal LED Trailing/Leading Edge Dimmer Module Page 234

LED Grid Dimmer Page 236

## Emergency Lighting

### Emergency Exit Signs

Spectrum LED Emergency Hinged Exit Box Page 238

### Emergency Exit Blades

Spectrum Emergency Exit Blade Page 242

Spectrum LED Emergency 6 in 1 Exit Blade Page 246

### Emergency Downlights

Spectrum LED Emergency Non Maintained Downlight Page 250

Spectrum LED Recessed Downlight Page 252

Spectrum LED Emergency Non Maintained Downlight Page 254

Spectrum 2W LED Emergency Non Maintained Downlight - Surface or Recessed Page 256



## Emergency Twin Spots

Spectrum LED Emergency IP65 Twin Spot Page 258

## Emergency Bulkheads

Spectrum LED Emergency Bulkhead / Recessed Page 260

Spectrum Pro LED High Power Emergency Bulkhead Page 264

## LED Lamps

### LED GU10 Dimming

Dimming Chart Page 270

### LED GU10 Lamps

LED Genesis GU10 Page 272

LED Halo GU10 Page 274

LED Halo Elite GU10 Page 278

LED Halo Glass GU10 Page 282

LED Halo Elite Glass GU10 Page 284

LED Dim to Warm GU10 Page 286

LED Long Neck GU10 Page 288

LED Pro Precision GU10 Page 290

### LED MR16 Lamps

LED LV Halo MR16 Page 292



## LED MR11 Lamps

LV LED Halo MR11 Page 294

## LED AR111 Lamps

LED AR111 Page 296

## LED PAR Lamps

LED PAR Lamp Page 298

LED External PAR 38 Lamp Page 302

## LED Filament Lamps

LED Filament Candle Page 304

LED Filament Round Page 310

LED Platinum Filament GLS Page 314

LED Filament GLS Page 316

LED Filament Squirrel Cage Page 320

LED Filament Tubular Page 322

LED Filament Clear Globe Page 324

## LED Fairy Lamps

LED Fairy Lamps Page 326

## LED Soft Coil Lamps

Aztex LED Soft Coil Candle, GLS & Squirrel Cage Page 328

Aztex LED Soft Coil Pear Drop & Large Globe Page 330

LED Soft Coil Gunmetal Large Globe & Squirrel Cage Page 332



## LED Vintage Lamps

LED Vintage Squirrel Cage Page 334

LED Vintage Globe Page 336

LED Vintage Candle Page 338

LED Vintage Tubular Page 340

## LED Aztex High CRI Lamps

Aztex LED High CRI Vintage Candle, GLS & Squirrel Cage Page 344

Aztex LED High CRI Vintage Globes Page 346

Aztex LED High CRI G9 & Pygmy Page 348

Aztex LED High CRI Vintage Tower Bubble Page 350

Aztex LED High CRI Vintage Bubble Page 352

Aztex LED High CRI Double Ended Strip Page 354

## LED Candle Lamps

LED Candle Page 356

## LED Round Lamps

LED Round Page 362

## LED GLS Lamps

LED GLS Page 366

LED Genesis GLS Page 372

## LED Photocell Lamps

LED Photocell GLS Page 374



## LED Reflectors

LED Reflector Page 376

## LED Appliance Lamps

LED Appliance Lamp Microwave/Fridge Page 378

LED Cooker Hood Page 378

LED Pygmy Page 378

## LED G4/G9 Capsules

LED G4 Capsule Page 380

LED G9 Capsule Page 380

## LED Square Lamps

LED Square 2/4 Pin Page 382

## LED 110V Lamps

LED 110V GLS Page 384

## LED Amenity Lamps

LED BLD Page 386

LED BLT Page 386

LED BLL Page 388

LED BLS Page 388

LED Strip Page 390

LED T8 Page 392

LED T5 Page 396



## CFL Lamps

BLD Page 400

BLT Page 402

BLS Page 404

BLL Page 406

T9 Triphosphor Circular Page 408

T5 Triphosphor Circular Page 410

Square Page 412

T5 Triphosphor Mini Tube Page 414

T5 Triphosphor High Efficiency Tube Page 416

T5 Triphosphor High Output Tube Page 418

T8 Triphosphor Tube Page 420



---

## Halogen Lamps

---

Class C Halogen Capsule	Page 422
LV Capsule UV Block	Page 422
Class 'C' Energy Saving 78/117mm R7's Linear	Page 424

---



---

## Incandescent Lamps

---

Appliance Lamps	Page 426
Pygmy/Small Sign	Page 428
Night Light	Page 428
Glossary	Page 430
WERCS Recycling	Page 435

---



## Energy Saving Calculations are now available whenever and wherever you are

BELL Lighting Energy Saving Calculator is a handy, easy to use tool for all lighting professionals. Simply enter your current and proposed lighting, along with electricity costs.

Hit calculate for full data including:

- Energy Saving
- Annual Cost Saving
- Savings Over Life Of Lamps
- Annual Energy Saving
- CO<sub>2</sub> Saving
- Built in option for control gear calculations



## Lighting Design, a dedicated team of specialist engineers ready to help

Our team of professional lighting designers and engineers have over 50 years of experience in the lighting industry. We know the importance of good lighting design and the benefits a lighting engineer will bring to a project. Our lighting design service ensures correct light levels are achieved in compliance with current regulations.

Our specialised knowledge of lighting and lighting control systems provides a smooth hassle free process, delivering beautiful energy saving lighting solutions on time and on budget.



Working within the UK and internationally, the lighting team have established a reputation for designing a broad range of exciting projects of all sizes, from single rooms through to partnerships with multi-disciplined design teams on large infrastructure projects.

We are a responsive and fast moving team who can manage the complete lighting design process from concept through to the tender & supply

For all internal, external & emergency projects contact:

[lightingdesign@belllighting.co.uk](mailto:lightingdesign@belllighting.co.uk)

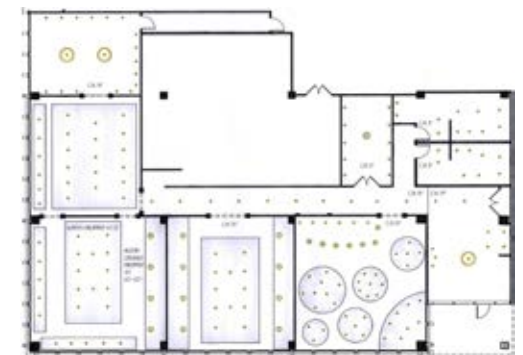





# The BELL Difference - Research, Quality Control & Testing Facilities

British Electric Lamps Ltd. was established in 1920 and has built a reputation within the industry for manufacturing quality products and providing excellent service to our customers.

British Electric Lamps Research and Development department was established in 2012, this was augmented by the Lighting Laboratory and the Quality Control/Quality Assurance facility in 2013.

Secure Life Testing Area situated on-site next to the National Distribution Centre, batch tests all manufactured items to ensure continuity to life standards.



Index

All products manufactured by British Electric Lamps undergo a stringent set of quality control procedures, carried out in accordance with the latest standards.

Be assured that when you choose BELL lamps or fittings you are getting the most energy efficient units available today, saving you money, energy and reducing your carbon footprint.



The Photometric Sphere tests all lamp output data; lumens, spectrum, colour temperature, power factor and actual power. This allows availability of photometric data and illumination data for lighting design schemes.



Thermal Imaging Cameras are used to ensure correct operation and thermal management of LED products. Thermal management is essential for LED products to prevent limited lamp life and lumen depreciation.

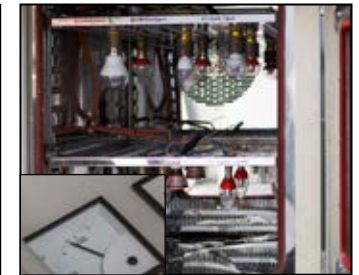

Extreme Electrical Conditions tests are carried out on each batch of our LED lamps in line with EN 62560:2012. All of the electrical safety tests are carried out after the lamps have aged at 35°C and 95% relative humidity in our environmental chamber.



Needle Flame Tests ensure that all insulating parts in lamps and fixtures are flame retardant.



Post production QC testing & inspection to ensure safe current protection of the product.



Circuit Overload Protection and circuit wattage is tested on product batches to ensure safety and compliance to EN60598.



Extensive Dimmer Compatibility Testing is performed on all LED products to ensure performance of smooth dimming, high loading compatibility and overall stability.



Cap Torque Test, calibrated torque test is carried out on all lamps to ensure products retain cap strength before and after life testing.



Glow Wire Test is performed on all lamps and fixtures to ensure that construction materials are self extinguishing.





## Expansion Moving forward into the new decade

Due to continued growth, BELL Lighting have expanded into additional warehousing facilities in the heart of West Yorkshire. With a combined 100,000 square feet, and stocking over 1800 individual product lines, BELL Lighting are able to deliver on time and on budget with our next day delivery service as standard.

To celebrate our centenary year, we have created our new state of the art conference facility, product showroom and entertainment suite. With the ability to cater for up to 50 people, this is the perfect venue for hosting conferences, meetings and product training sessions.

**2013**  
New laboratory and Quality Control facility built on-site in Normanton to meet requirements for new stringent EU safety and performance standards.

**2020**  
We will continue to develop innovative LED lighting products, including a range of smart lamps perfect for home, commercial & hospitality lighting automation.

**2023**  
Moved in to our new home BELL House with 100,000 ft<sup>2</sup> warehousing capacity, showroom, conference facility & hospitality centre.



## BELL celebrates over 100 years in business 1920-2023!

In May 1920 Edwin Grote, founder, established an incandescent lamp factory in Wimbledon, London manufacturing unique incandescent decorative light sources. The company is still completely owned by Chairman Michael Grote and Managing Directors Trevor & Ralph Grote.

**1920**  
Mr E R Grote, Founder, established an incandescent lamp factory in Wimbledon, manufacturing unique incandescent decorative lights.

**1940**  
During World War 2 the lamp making machinery was converted to produce components for the military to help fight against the German war machine.

**1980**  
A national distribution centre was established in West Yorkshire to facilitate national next day delivery across the UK and Southern Ireland.



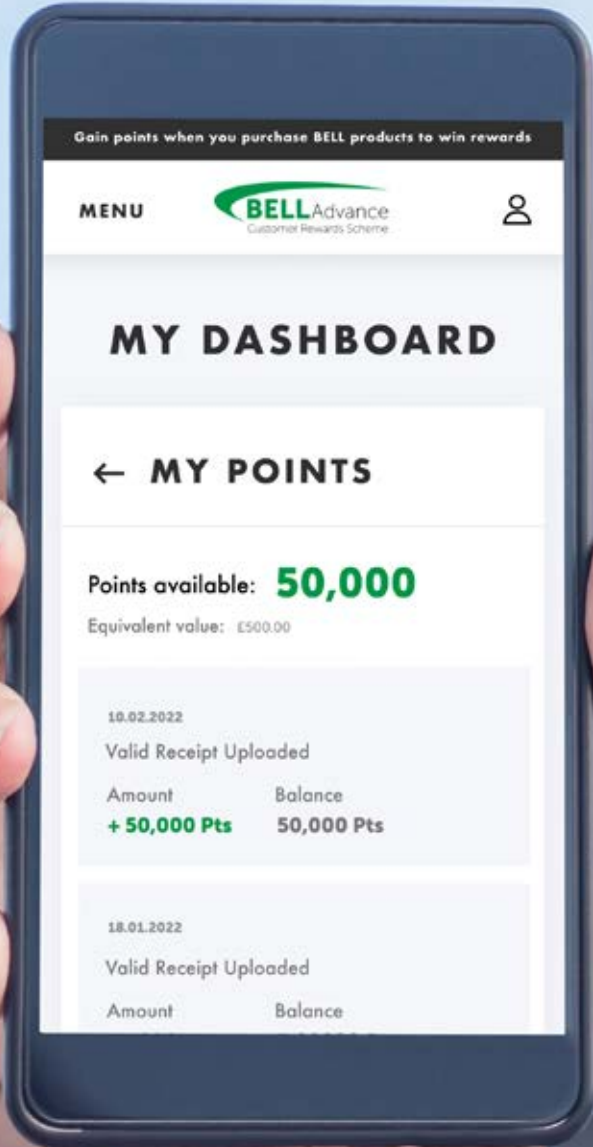

# Customer Rewards Scheme



As a thank you, we have launched our brand new BELL Advance Customer Rewards Scheme. Our aim is to reward loyalty, the more you spend, the more we give back to you, the contractor.

All you have to do is follow these 3 simple steps:

- 1 **Register** at [www.belladvance.co.uk](http://www.belladvance.co.uk) and receive your complimentary reward points along with automatic entry to our monthly prize draw.
- 2 **Buy** BELL Lighting Products & collect points, take a photo of your invoice and upload.
- 3 **Redeem** once you have accumulated your well-earned points, simply redeem your rewards in the form of retail vouchers, emailed direct to your inbox.

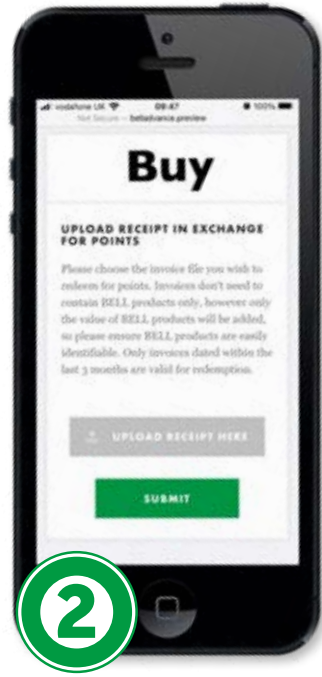
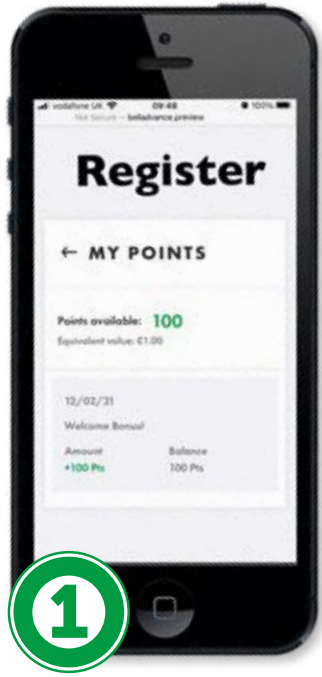

See above website for full terms & conditions



## Asymmetric LED Floodlight

The Skyline Powertron Asymmetric LED Floodlight is the highest lumen output floodlight ever produced by BELL. The black powder coated die cast aluminium construction gives an ultra-modern aesthetic combined with a staggering 283,000 lumen output (1800W). The rugged, robust construction of the Powertron makes this fitting ideal for external sports facilities open to the elements.

- 600/1200/1800W Modular Body Design
- Genuine replacement for 1000W/2000W Metal Halide Floodlights
- Up to 157 Lm/W
- IP66
- Fully adjustable angled mounting bracket
- Suitable for multiple row columns installation
- Angle markings on bracket for easy alignment
- Scope available on request for fine on site aiming
- Full cut-off horizontal asymmetric floodlight
- Low weight & windage
- Optional ULR Shields available for 0% upward light, glare and obstructive light reduction
- Remote driver gear tray, can be mounted on ground level for easy maintenance

600W  $\equiv$  1000 W MH Energy Saving 40%  
 1200W  $\equiv$  2000 W MH Energy Saving 40%

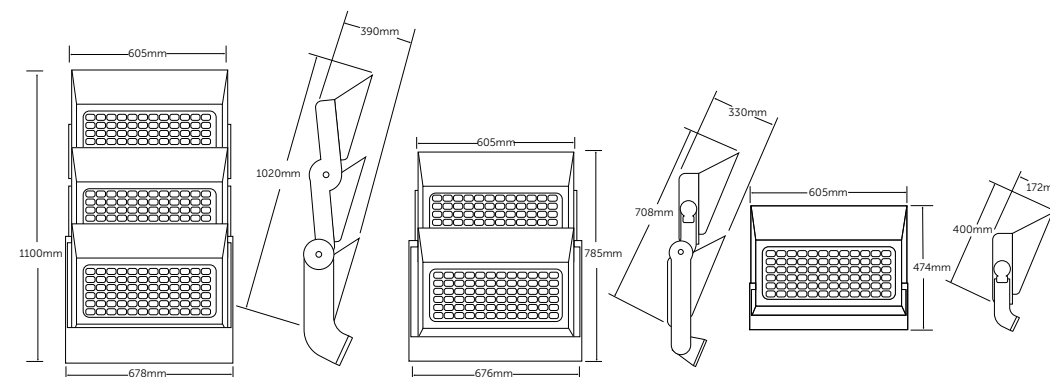

Dimensions include optional Deep ULR Shields



Images show with optional Deep Visors



# Asymmetric LED Floodlight

Code	W	Description	Lm (up to)	Temp	Lm/W (up to)	Hours
11330	600	Powertron 600W 4000K NAB Floodlight	94,200	4000K	157	100,000
11829	600	Powertron 600W 4000K MAB Floodlight	92,600	4000K	154	100,000
11830	600	Powertron 600W 4000K WAB Floodlight	92,800	4000K	155	100,000
11331	1200	Powertron 1200W 4000K NAB Floodlight	188,650	4000K	157	100,000
11831	1200	Powertron 1200W 4000K MAB Floodlight	186,000	4000K	155	100,000
11832	1200	Powertron 1200W 4000K WAB Floodlight	185,900	4000K	155	100,000
11332	1800	Powertron 1800W 4000K NAB Floodlight	283,330	4000K	157	100,000
11833	1800	Powertron 1800W 4000K MAB Floodlight	280,450	4000K	156	100,000
11834	1800	Powertron 1800W 4000K WAB Floodlight	280,260	4000K	156	100,000
11341		Deep Visor for Skyline Powertron				
11345		Shallow Visor for Skyline Powertron				
11828		360° Visor for Skyline Powertron				
11346		Aiming Scope for Skyline Powertron				

Please note; if using shields order:  
 1 for 600W  
 2 for 1200W  
 3 for 1800W  
 440V Available on request



# Asymmetric LED Floodlight

Technical Specification	
Construction	Black powder coated die cast aluminium (RAL 9017)
Driver	600W & 1200W UPowerTek / 1800W BELL
LED Chip	OSRAM 3737
IP Rating	IP66
Operating Temp	-30°C to +35°C
Controls	0-10V or DALI, please specify when ordering. DMX / PWM special order
Power Factor	> 0.9
Input Voltage	200-240
CRI	70 - Exceeds EU standard of Ra70 for Colour Rendering Index
LMR	80 - Exceeds EU standard of 70 for Lumens Maintenance Ratio
Weight	Remote Driver: 600W 8.9Kg / 1200W 20.5Kg / 1800W 36Kg Including Driver: 600W 13.2Kg / 1200W 31.8Kg / 1800W 41.5Kg
Windage/EPA	600W 0.09m <sup>2</sup> @ 0° / 1200W 0.22m <sup>2</sup> @ 0° / 1800W 0.40m <sup>2</sup> @ 0°

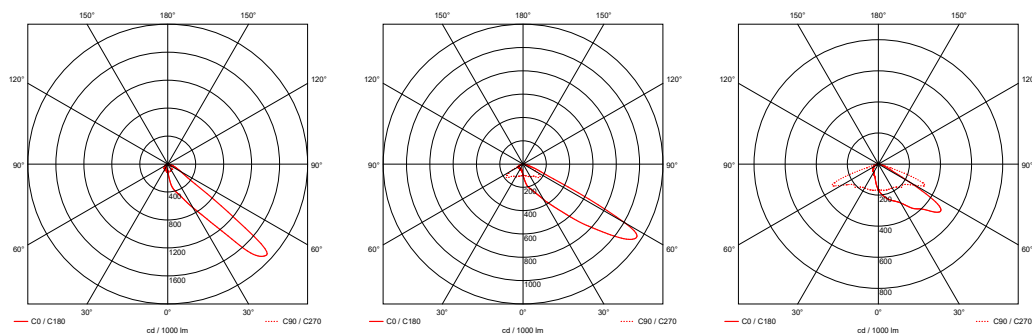

Narrow Asymmetric Beam

Medium Asymmetric Beam

Wide Asymmetric Beam

Index

<sup>1</sup> Exceeds EU standard of 70 for Lumens Maintenance Ratio  
<sup>2</sup> Exceeds EU standard of RA 70 for Colour Rendering Index  
<sup>3</sup> Subject to terms & conditions (Contact Customer Service)



Technical Helpline +44 (0)1924 893380



Index





## Skyline Padel

### Wattage Switchable LED Padel Floodlight

Padel is a form of Tennis which originated in Mexico in 1969, the sport is rapidly expanding across Europe. Popularity is growing in the UK and the LTA expects to have a total of 400 Padel courts in place by 2024.

Most Padel courts in the UK use standard Asymmetric Floodlights which would be expected for use in general external areas. The Skyline Padel sets itself apart as a use specific product, designed for Padel Tennis, with optional visors and tailored light distribution to allow for reduced spillage.

The wattage switchable functionality of the Padel allows for a flexible approach to lighting levels, with the fitting allowing the user to move between regional/recreational and national/international competition lighting levels.

- Perfect for Padel Courts
- Genuine replacement for 600/1000W floodlight
- Up to 68% energy saving
- Super Slimline Design
- Fully encapsulated IP65 TUV certified driver
- Rated voltage 100/240V
- Front and rear spill visor available (Code: 11901)
- 4 x Skyline Padel Floodlights per court at 240W, achieves LTA Regional Competition and Recreational compliance of >300 lux
- 4 x Skyline Padel Floodlights per court at 320W, achieves LTA National and International Competition compliance of >500 lux

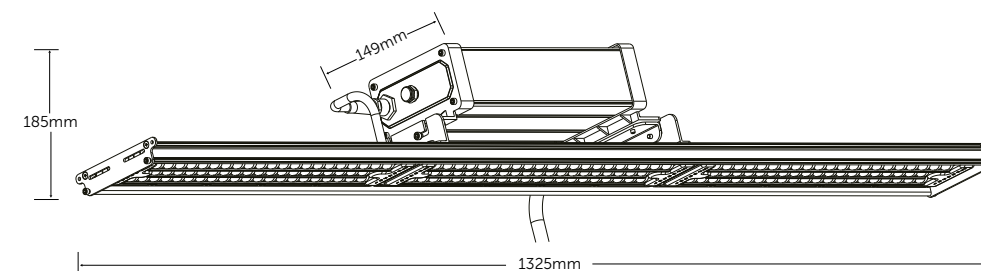

# Skylinepadel

## Wattage Switchable LED Padel Floodlight

### Technical Specification

Construction	Powder coated extruded aluminium (RAL870-3)
Driver	Sosen
LED Chip	BMTC 5050
IP Rating	IP65
Operating Temp	-30°C to +50°C
Controls	1-10V, Dimmable (DALI special order)
Power Factor	> 0.9
Input Voltage	100-240
CRI	70 - Exceeds EU standard of Ra70 for Colour Rendering Index
LMR	80 - Exceeds EU standard of 70 for Lumens Maintenance Ratio
Weight	6.6Kg
Windage/EPA	0.1m <sup>2</sup> @ 0°

Code	W	Description	Lm	Temp	Lm/W	Hours
11900	240 320	Wattage Switchable LED Skyline Padel Floodlight	39000 52000	4000K	162	50,000
11901	-	Set of visors for above	-	-	-	-

Index

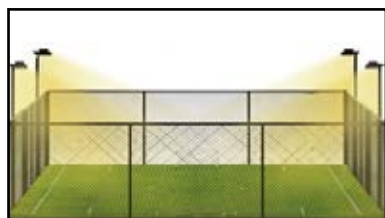

Four Skyline Padel lights are sufficient to cover one padel court, saving on both lighting fixtures and installation costs.



With advanced asymmetrical intense 40.5° optics, the lighting fixture can be horizontally installed without any complex adjustment.

Padel court are a standard size, which means that you can easily produce lighting calculation, and simply adjust the fitting to the right angle when mounting.

<sup>1</sup> Exceeds EU standard of 70 for Lumens Maintenance Ratio  
<sup>2</sup> Exceeds EU standard of RA 70 for Colour Rendering Index  
<sup>3</sup> Subject to terms & conditions (Contact Customer Service)







# SkylineELITE+

## Symmetric LED Floodlight

Skyline Elite+ represents the latest technology in sports floodlighting, modern aesthetic & die-cast aluminium construction. With IP66 and low windage ratings this unit can handle the worst weather conditions. Perfect for large external sports facilities or industrial applications, complete with a fully adjustable mounting bracket.

- 600W Symmetric Floodlight
- Genuine replacement for 1500W Metal Halide
- Up to 155 Lm/W
- IP66
- Visor for low upward light
- Low weight & windage when compared with HID luminaires
- Fully adjustable mounting bracket
- Angle markings for easy alignment

600W  $\equiv$  1500W MH Energy Saving 60%



LMR80: Maximum 20% of lumen depreciation over rated hours.

B10: Maximum 10% of fittings failure rate over rated hours

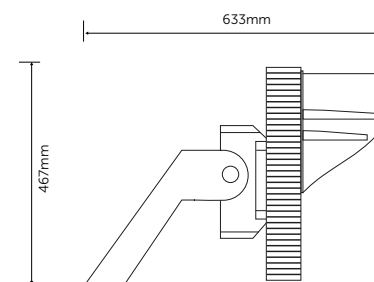

# SkylineELITE+

## Symmetric LED Floodlight

### Technical Specification

Construction	Die Cast LM6 Aluminium & Polycarbonate lens
Driver	Inventronics 1-10V Dim
LED Chip	Sosen
IP Rating	IP66
Operating Temp	-30°C to +35°C
Input Voltage	100 - 277V (277 - 440V special order)
Power Factor	> 0.9
CRI	80 - Exceeds EU standard of Ra 70 for Colour Rendering Index
LMR	80 - Exceeds EU standard of 70 for Lumens Maintenance Ratio
Weight	18.6 Kg
Windage	0.11M <sup>2</sup>

Code	V	W	Description	Lm	Peak Intensity	Temp	Lm/W	Hours
10770	100-277	600	Symmetric LED Floodlight 60°	89000	1192.90 cd/klm @ 10°	4000K	148	70000
10771	100-277	600	Symmetric LED Floodlight 30°	93000	2460.60 cd/klm @ 0°	4000K	155	70000

<sup>1</sup> Exceeds EU standard of 70 for Lumens Maintenance Ratio  
<sup>2</sup> Exceeds EU standard of RA 70 for Colour Rendering Index  
<sup>3</sup> Subject to terms & conditions (Contact Customer Service)

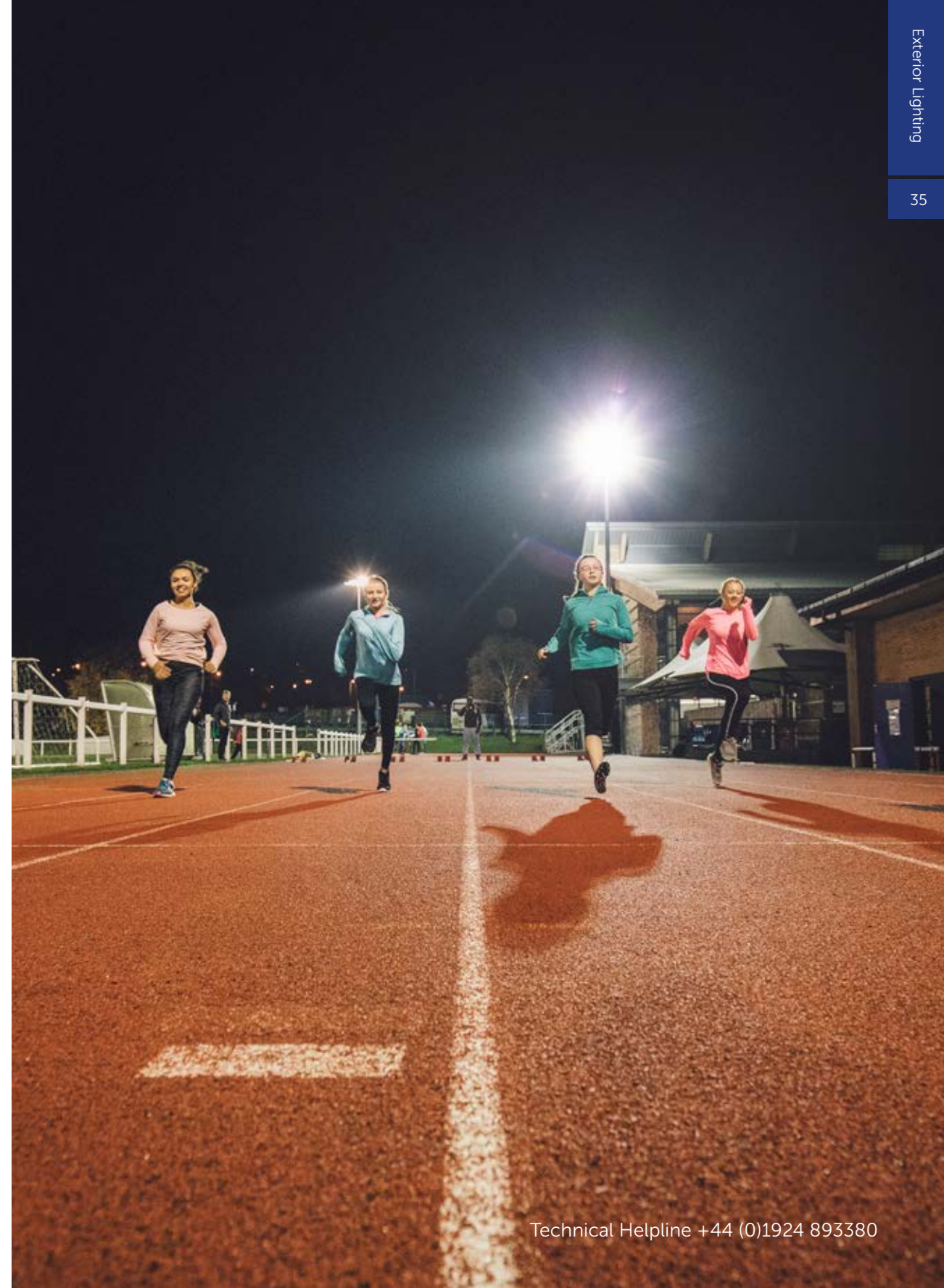



# SkylineELITE+

## High Output Asymmetric LED Floodlight

Skyline Elite+ represents the latest technology in sports floodlighting. Modern aesthetic, die-cast aluminium construction. With IP66 and low windage ratings this unit can handle the worst weather conditions. Perfect for large external sports facilities or industrial applications, complete with a fully adjustable mounting bracket.

- Genuine replacement for up to 1500W Metal Halide Floodlight
- Perfect for sports, building facade's, landscape, security & car park lighting
- Asymmetric distribution, low light pollution
- 145 Lm/W
- Aerodynamic, streamlined design for reduced windage
- Fully encapsulated IP66 TUV certified driver
- Nichia GRT-V1 LED
- Fully adjustable mounting bracket

600W  $\approx$  1500 W MH Energy Saving 60%



LMR80: Maximum 20% of lumen depreciation over rated hours.  
B10: Maximum 10% of fittings failure rate over rated hours

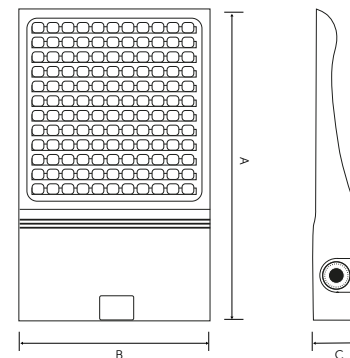

High Output Asymmetric LED Floodlight	
A	621mm
B	601mm
C	104mm



# SkylineELITE+

## High Output Asymmetric LED Floodlight

### Technical Specification

Construction	Polyester coated die-cast LM6 Marine Grade aluminium & toughened safety glass
Driver	Sosen (1-10V dimmable)
LED Chip	Nichia GRT-V1
IP Rating	IP66
Operating Temp	-30°C to +45°C
Input Voltage	100 - 277V (277 - 440V special order)
Power Factor	> 0.9
CRI	80 - Exceeds EU standard of Ra 70 for Colour Rendering Index
LMR	80 - Exceeds EU standard of 70 for Lumens Maintenance Ratio
Windage	0.37M <sup>2</sup>
Weight	18Kg

Code	V	W	Description	Lm	Peak Intensity	Temp	Lm/W	Hours
08873	110-277	600	Skyline Elite+ Asymmetric Floodlight IP66 Type 2	87000	474.60 cd/klm @ 32°	4000K	145	70000
08874	110-277	600	Skyline Elite+ Asymmetric Floodlight IP66 Type 3	87000	488.20 cd/klm @ 44°	4000K	145	70000
08875	110-277	600	Skyline Elite+ Asymmetric Floodlight IP66 Type 4	87000	546.50 cd/klm @ 60°	4000K	145	70000

<sup>1</sup> Exceeds EU standard of 70 for Lumens Maintenance Ratio  
<sup>2</sup> Exceeds EU standard of RA 70 for Colour Rendering Index  
<sup>3</sup> Subject to terms & conditions (Contact Customer Service)

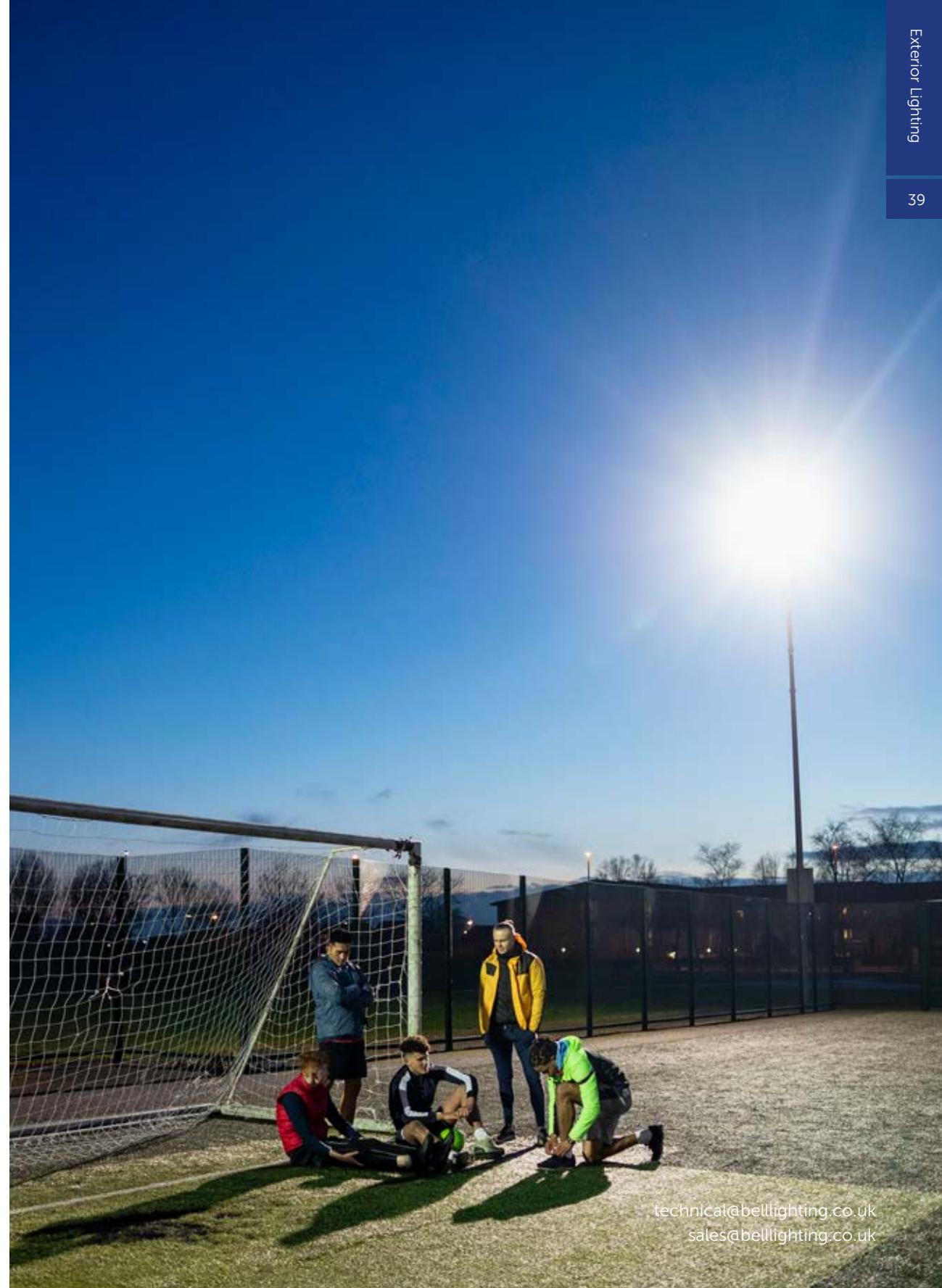

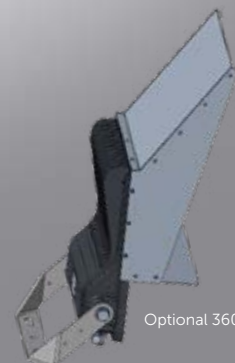

Optional 360° Visor

## Asymmetric/Symmetric LED Floodlight

Designed and engineered in the UK specifically to meet the requirements for sports lighting and to reduce light pollution levels. The Skyline Virtus is a high specification floodlight, wattage switchable as standard with a 50,000 hour lifespan, 7 year warranty and 2 year on site warranty.

- Genuine replacement for 250/500/750W Metal Halide/Sodium Floodlight
- Wattage Switchable
- Perfect for sports, building facade, landscape, security & car park lighting
- Asymmetric distribution, low light pollution (Asymmetric version)
- 155 Lm/W
- Surge protected 10,000V
- Aerodynamic, streamlined design for reduced windage
- Fully encapsulated IP66 TUV certified driver
- Nichia GRT-V1 LED
- Long life 50,000 hours (L80 B10 @ 25°C)
- Robust construction, supplied with standard universal mounting bracket
- Supplied pre-flexed (1.5M)
- Air pressure equalisation feature to eliminate capillary effect

100W  $\equiv$  250 W MH/SON Energy Saving 60%    200W  $\equiv$  500 W MH/SON Energy Saving 60%    300W  $\equiv$  750 W MH/SON Energy Saving 60%



LMR80: Maximum 20% of lumen depreciation over rated hours. B10: Maximum 10% of fittings failure rate over rated hours

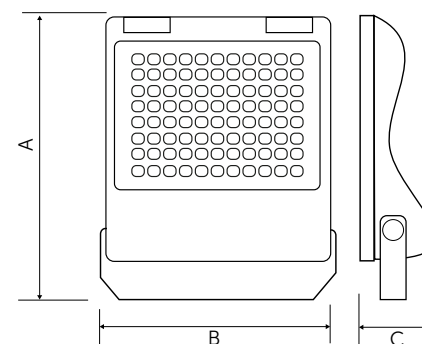

	50/75/100W	100/150/200W	100/225/300W
A	353mm	447mm	495mm
B	287mm	359mm	419mm
C	65mm	75mm	75mm

<sup>1</sup> Exceeds EU standard of 70 for Lumens Maintenance Ratio  
<sup>2</sup> Exceeds EU standard of RA 80 for Colour Rendering Index  
<sup>3</sup> Subject to terms & conditions (Contact Customer Service)



# Skylinevirtus

## Technical Specification

Construction	Polyester coated die-cast LM6 Marine Grade aluminium & toughened safety glass
Driver	LiFud
LED Chip	Nichia GRT-V1
IP Rating	IP66
Operating Temp	-30°C to +35°C
Input Voltage	110 - 240V
Power Factor	> 0.9
CRI	80 - Exceeds EU standard of Ra 70 for Colour Rendering Index
LMR	80 - Exceeds EU standard of 70 for Lumens Maintenance Ratio
Windage/EPA	100W 0.067M <sup>2</sup> / 200W 0.112M <sup>2</sup> / 300W 0.144M <sup>2</sup>
Weight	100W - 2.8Kg / 200W - 5.2Kg / 300W - 6.4Kg

Code	V	W	Description	Lm	Peak Intensity	Temp	Lm/W	Hours
11485	110-240	50/75/100	Skyline Virtus Switchable Asymmetric Floodlight	7700-15450	558 cd/klm @ 53°	4000K	152	50000
11486	110-240	50/75/100	Skyline Virtus Wattage Switchable Symmetric Floodlight	7500-15100	1400 cd/klm @ 13°	4000K	148	50000
11482	110-240	50/75/100	Skyline Virtus Wattage Switchable 30° Floodlight	7400-15950	3074 cd/klm @ 0°	4000K	157	50000
11489	110-240	100/150/200	Skyline Virtus Wattage Switchable Asymmetric Floodlight	15450-30300	518 cd/klm @ 58°	4000K	152	50000
11490	110-240	100/150/200	Skyline Virtus Wattage Switchable Symmetric Floodlight	15100-30050	1142 cd/klm @ 11°	4000K	148	50000
11483	110-240	100/150/200	Skyline Virtus Wattage Switchable 30° Floodlight	15950-30900	3086 cd/klm @ 0°	4000K	156	50000
11491	110-240	150/225/300	Skyline Virtus Wattage Switchable Asymmetric Floodlight	22400-46050	562 cd/klm @ 57°	4000K	154	50000
11492	110-240	150/225/300	Skyline Virtus Wattage Switchable Symmetric Floodlight	21850-45650	1311 cd/klm @ 10°	4000K	150	50000
11484	110-240	150/225/300	Skyline Virtus Wattage Switchable 30° Floodlight	23400-47800	2890 cd/klm @ 0°	4000K	158	50,000
11581	-	-	360° Visor for 50/75/100W	-	-	-	-	-
11583	-	-	360° Visor for 100/150/200W	-	-	-	-	-
11585	-	-	360° Visor for 150/225/300W	-	-	-	-	-

<sup>1</sup> Exceeds EU standard of 70 for Lumens Maintenance Ratio

<sup>2</sup> Exceeds EU standard of RA 70 for Colour Rendering Index

<sup>3</sup> Subject to terms & conditions (Contact Customer Service)

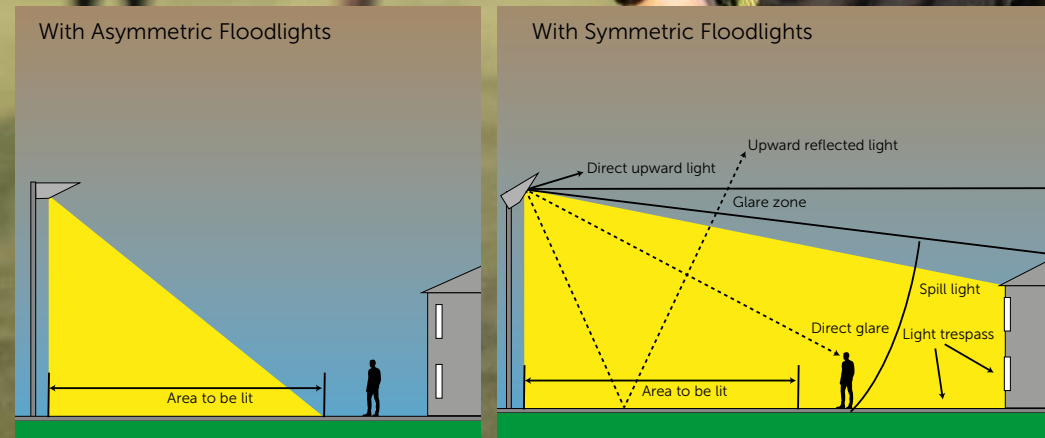



#### Boston Spa Tennis Club: BELL Skyline Virtus

Over the life of the fitting, Boston Spa Tennis Club could save: £69,300 in energy costs, energy saving 60%

- Annual Energy Saving 4368 kWh
- Annual CO<sub>2</sub> Saving 2446 Kg
- Annual Maintenance £2500





# Skylineslim+

## LED Floodlight

The Skyline Slim+ LED Floodlight is suitable for a wide range of applications. Available in a vast range of wattages, this low energy floodlight is ideal for any lighting project, big or small.

- 10/20/30/50W Genuine replacement for Halogen Floodlights
- 70/100/150/200W Genuine replacement for Metal Halide Floodlights
- Marine Grade Aluminium body
- Fully encapsulated IP65 TUV certified driver
- PIR Over-ride function
- Average 8M detection range for PIR Floods
- Separately tested IP65 PIR

10W $\equiv$ 120W Energy Saving 91%	20W $\equiv$ 160W Energy Saving 88%	30W $\equiv$ 240W Energy Saving 88%	50W $\equiv$ 400W Energy Saving 88%
70W $\equiv$ 100W MH Energy Saving 30%	100W $\equiv$ 150W MH Energy Saving 33%	150W $\equiv$ 250W MH Energy Saving 40%	200W $\equiv$ 400W MH Energy Saving 50%



LMR80: Maximum 20% of lumen depreciation over rated hours.  
 B10: Maximum 10% of fittings failure rate over rated hours

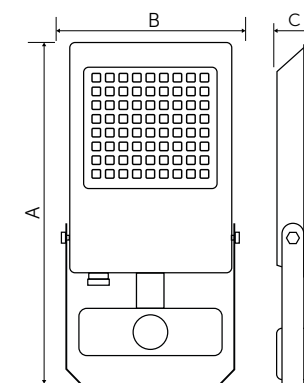

Without PIR Symmetric

	10W	20W	30W	50W	70W	100W	150W	200W
A	134mm	142mm	158mm	200mm	259mm	318mm	357mm	410mm
B	112mm	120mm	136mm	172mm	229mm	276mm	300mm	355mm
C	31mm	33mm	34mm	44mm	48mm	60mm	60mm	60mm

Asymmetric Without PIR

	50W	70W	100W	150W	200W
A	231mm	315mm	315mm	351mm	408mm
B	194mm	235mm	277mm	302mm	352mm
C	48mm	60mm	60mm	60mm	60mm

With PIR Symmetric

	10W	20W	30W	50W	70W
A	176mm	185mm	200mm	239mm	300mm
B	112mm	120mm	137mm	172mm	229mm
C	68mm	68mm	72mm	72mm	72mm

# Skylineslim+

## LED Floodlight

Technical Specification	
Construction	Die Cast LM6 Marine Grade Aluminium body, Stainless Steel screws and fixings
Driver	BELL
LED Chip	Phillips
IP Rating	IP65
Operating Temp	-20°C to +25°C Outdoor use only
Input Voltage	240V
Power Factor	> 0.9
CRI	80 - Exceeds EU standard of Ra 70 for Colour Rendering Index
LMR	80 - Exceeds EU standard of 70 for Lumens Maintenance Ratio
Windage	10W Non PIR 0.009M <sup>2</sup> / 10W PIR 0.009M <sup>2</sup> / 20W Non PIR 0.010M <sup>2</sup> / 20W PIR 0.010M <sup>2</sup> 30W Non PIR 0.014M <sup>2</sup> / 30W PIR 0.014M <sup>2</sup> / 50W Non PIR 0.022M <sup>2</sup> / 50W PIR 0.022M <sup>2</sup> 70W Non PIR 0.043M <sup>2</sup> / 70W PIR 0.043M <sup>2</sup> / 100W Non PIR 0/062M <sup>2</sup> / 150W Non PIR 0.080M <sup>2</sup> / 200W Non PIR 0.112M <sup>2</sup>  50W Asymmetric 0.044M <sup>2</sup> / 70W Asymmetric 0.074M <sup>2</sup> / 100W Asymmetric 0.062M <sup>2</sup> 150W Asymmetric 0.080M <sup>2</sup> / 200W Asymmetric 0.112M <sup>2</sup>
Weight	10W Non PIR 0.3Kg / 10W PIR 0.4Kg / 20W Non PIR 0.4Kg / 20W PIR 0.5Kg / 30W Non PIR 0.5Kg / 30W PIR 0.6Kg / 50W Non PIR 0.8Kg / 50W PIR 1.0Kg / 70W Non PIR 1.1Kg / 70W PIR 1.2Kg / 100W Non PIR 3.1Kg / 150W Non PIR 3.8Kg / 200W Non PIR 5.0Kg  50W Asymmetric 0.8Kg / 70W Asymmetric 1.1Kg 100W Asymmetric 3.2Kg / 150W Asymmetric 3.8Kg / 200W Asymmetric 5.0Kg

# Skylineslim+

## LED Floodlight

Code	V	W	Description	Lm	Peak Intensity	Temp	Lm/W	Hrs
10980	240	10	10W Skyline Slim+ LED Floodlight	1200	384.2 @ 0°	4000	120	50000
10981	240	20	20W Skyline Slim+ LED Floodlight	2400	377 @ 0°	4000	120	50000
10982	240	30	30W Skyline Slim+ LED Floodlight	3600	376.8 @ 0°	4000	120	50000
10983	240	50	50W Skyline Slim+ LED Floodlight	6000	394.4 @ 0°	4000	120	50000
10984	240	70	70W Skyline Slim+ LED Floodlight	8400	387.4 @ 0°	4000	120	50000
10990	240	100	100W Skyline Slim+ LED Floodlight	12000	384.2 @ 0°	4000	120	50000
10991	240	150	150W Skyline Slim+ LED Floodlight	18000	377 @ 0°	4000	120	50000
10992	240	200	200W Skyline Slim+ LED Floodlight	24000	376.8 @ 0°	4000	120	50000
10985	240	10	10W Skyline Slim+ PIR LED Floodlight	1200	394.4 @ 0°	4000	120	50000
10986	240	20	20W Skyline Slim+ PIR LED Floodlight	2400	387.4 @ 0°	4000	120	50000
10987	240	30	30W Skyline Slim+ PIR LED Floodlight	3600	376.5 @ 0°	4000	120	50000
10988	240	50	50W Skyline Slim+ PIR LED Floodlight	6000	363.3 @ 0°	4000	120	50000
10989	240	70	70W Skyline Slim+ PIR LED Floodlight	8400	367.6 @ 0°	4000	120	50000
10995	240	50	50W Skyline Slim+ Asymmetric LED Floodlight	6000	890 @ 35°	4000	120	50000
10996	240	70	70W Skyline Slim+ Asymmetric LED Floodlight	8400	934 @ 38°	4000	120	50000
10977	240	100	100W Skyline Slim+ Asymmetric LED Floodlight	11000	875.6 @ 37°	4000	110	50000
10978	240	150	150W Skyline Slim+ Asymmetric LED Floodlight	16500	928.5 @ 40°	4000	110	50000
10979	240	200	200W Skyline Slim+ Asymmetric LED Floodlight	22000	882.7 @ 39°	4000	110	50000

<sup>1</sup> Exceeds EU standard of 70 for Lumens Maintenance Ratio  
<sup>2</sup> Exceeds EU standard of RA 70 for Colour Rendering Index  
<sup>3</sup> Subject to terms & conditions (Contact Customer Service)



Index



# skylinecosmos

## LED Asymmetric Floodlight

The Asymmetric Floodlight is suitable for a wide range of applications, dark sky friendly means that they minimise glare while reducing light trespass and skyglow. Perfect for National Parks and designated dark sky areas.

You might only see 5 -10 stars with the naked eye in a town or city. However, away from street lights in a National Park, you can often see over 2,000 stars – and even see our galaxy, the Milky Way, stretching across the sky.

- Genuine replacement for Halogen Floodlight
- Warm White (to minimise blue light)
- Super Slimline Design
- SMD LED
- Marine Grade Aluminium
- Complies with International Dark Skies Association recommendations

30W  $\equiv$  240W Energy Saving 88%



LMR80: Maximum 20% of lumen depreciation over rated hours.  
B10: Maximum 10% of fittings failure rate over rated hours

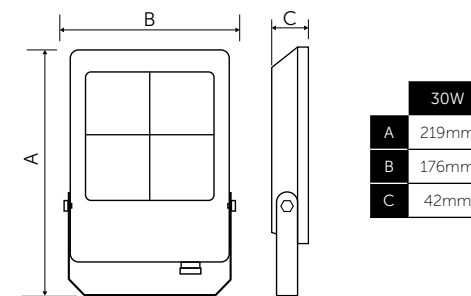



# Skylineecosmos

## LED Asymmetric Floodlight

### Technical Specification

Construction	Die Cast LM6 Marine Grade Aluminium body, Stainless Steel screws and fixings
Driver	Bell
LED Chip	Samsung
IP Rating	IP65
Operating Temp	-20°C to +25°C Outdoor use only
Input Voltage	110 - 240V
Power Factor	> 0.9
CRI	80 - Exceeds EU standard of Ra 70 for Colour Rendering Index
LMR	80 - Exceeds EU standard of 70 for Lumens Maintenance Ratio
Windage	30W 0.038M <sup>2</sup>
Weight	30W 0.9Kg

Code	V	W	Description	Lm	Peak Intensity	Temp	Lm/W	Hrs
10937	110/240	30	30W Skyline Cosmos Asymmetric Floodlight	3300	694 cd/klm @ 45°	3000K	110	50000

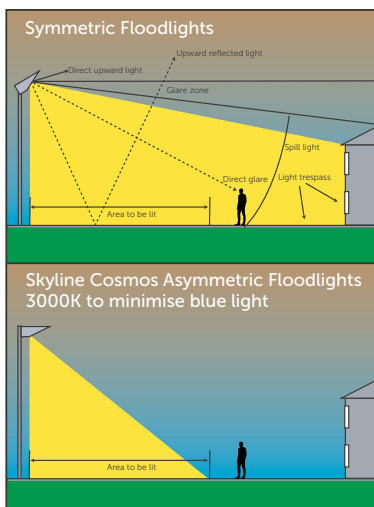

<sup>1</sup> Exceeds EU standard of 70 for Lumens Maintenance Ratio  
<sup>2</sup> Exceeds EU standard of RA 70 for Colour Rendering Index  
<sup>3</sup> Subject to terms & conditions (Contact Customer Service)





# SkylineMini

## LED Floodlight

The Skyline Mini LED Floodlight offers a super slim compact design ideal for domestic and commercial premises. Available in a variety of wattages with the option to include a PIR.

- Genuine replacement for Halogen Floodlight
- Super slim compact design
- SMD LED
- Die-cast Aluminium
- Separately tested IP65 PIR Sensor (PIR versions)
- PIR Over-ride function (PIR versions)
- Average 8M detection range for PIR Floods
- 4000K

10W $\equiv$ 120W Energy Saving 91%	20W $\equiv$ 160W Energy Saving 88%	30W $\equiv$ 240W Energy Saving 88%	50W $\equiv$ 400W Energy Saving 88%
-------------------------------------	-------------------------------------	-------------------------------------	-------------------------------------

Quality Assured 3 YEAR Product Warranty	LM80 80 Lumen Maintenance Ratio	Colour Rendering Index 80	IP65 Weather & Dust Protection Fitting	IK8 Impact Rating	Contact Us For SLL Standard Lighting Design	Grounding Symbol
---	---------------------------------------	------------------------------	--	----------------------	--	------------------

LM80: Maximum 20% of lumen depreciation over rated hours.  
B10: Maximum 10% of fittings failure rate over rated hours

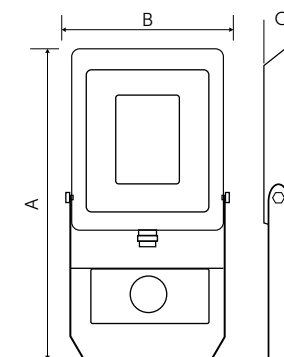

Without PIR

	10W	20W	30W	50W
A	100mm	114mm	135mm	172mm
B	91mm	112mm	142mm	183mm
C	28mm	28mm	28mm	28mm

With PIR

	10W	20W	30W	50W
A	127mm	137mm	162mm	194mm
B	91mm	112mm	142mm	183mm
C	54mm	54mm	54mm	54mm



# Skyline Mini

## LED Floodlight

### Technical Specification

Construction	Die Cast Aluminium body, Stainless Steel screws and fixings
Driver	BELL
LED Chip	BELL
IP Rating	IP65
Operating Temp	-10°C to +25°C Outdoor use only
Input Voltage	240V
Power Factor	> 0.9
CRI	80 - Exceeds EU standard of Ra 70 for Colour Rendering Index
LMR	80 - Exceeds EU standard of 70 for Lumens Maintenance Ratio
Windage	10W 0.009M <sup>2</sup> / 20W 0.013M <sup>2</sup> / 30W 0.019M <sup>2</sup> / 50W 0.031M <sup>2</sup> 10W PIR 0.012M <sup>2</sup> / 20W PIR /0.015XM <sup>2</sup> / 30W PIR 0.023M <sup>2</sup> / 50W PIR 0.036M <sup>2</sup>
Weight	10W 0.22Kg / 10W PIR 0.26Kg / 20W 0.27Kg / 20W PIR 0.31Kg / 30W 0.38Kg / 30W PIR 0.42Kg 50W 0.55Kg / 50W PIR 0.59Kg

Code	V	W	Description	Lm	Temp	Lm/W	Hours
10780	220-240	10	10W Skyline Mini LED Floodlight	1100	4000K	110	25000
10781	220-240	10	10W Skyline Mini LED PIR Floodlight	1100	4000K	110	25000
10782	220-240	20	20W Skyline Mini LED Floodlight	2200	4000K	110	25000
10783	220-240	20	20W Skyline Mini LED PIR Floodlight	2200	4000K	110	25000
10784	220-240	30	30W Skyline Mini LED Floodlight	3300	4000K	110	25000
10785	220-240	30	30W Skyline Mini LED PIR Floodlight	3300	4000K	110	25000
10786	220-240	50	50W Skyline Mini LED Floodlight	5500	4000K	110	25000
10787	220-240	50	50W Skyline Mini LED PIR Floodlight	5500	4000K	110	25000

<sup>1</sup> Exceeds EU standard of 70 for Lumens Maintenance Ratio

<sup>2</sup> Exceeds EU standard of RA 70 for Colour Rendering Index

<sup>3</sup> Subject to terms & conditions (Contact Customer Service)





## LED CCT Wallpack

Designed to be used where the aesthetics of the light fitting, along with a tough robust construction is needed. The fittings are IP65 and IK8 compliant, supplied complete with an opal diffuser for even light distribution. Available in emergency and non emergency versions.

- Genuine replacement for 70W Metal Halide & Sodium
- High impact polycarbonate construction
- 68% energy saving
- 30000 hours

### Options

- Photocell version
- Emergency / Emergency Photocell version

22W  $\equiv$  70W Energy Saving 68%



LMR80: Maximum 20% of lumen depreciation over rated hours.

B10: Maximum 10% of fittings failure rate over rated hours

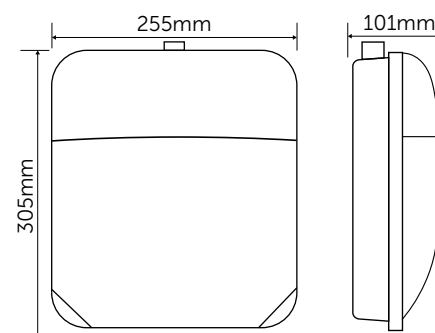





## LED CCT Wallpack

### Technical Specification

Construction	Polycarbonate Base & Lens
Driver	BELL
LED Chip	Samsung
IP Rating	IP65
Operating Temp	-30°C to +35°C / Emergency version minimum temperature 0°C
Input Voltage	240V
Power Factor	> 0.9
CRI	80 - Exceeds EU standard of Ra 70 for Colour Rendering Index
LMR	80 - Exceeds EU standard of 70 for Lumens Maintenance Ratio

Code	V	W	Description	Lm	Lm/W	Beam Angle	Temp	Hours
11350	220-240	22	Muro CCT LED Wallpack	1600	72	120°	3000/4000K	30000
11351	220-240	22	Muro CCT LED Wallpack Emergency	1600	72	120°	3000/4000K	30000
11352	220-240	22	Muro CCT LED Wallpack Microwave Sensor	1600	72	120°	3000/4000K	30000
11353	220-240	22	Muro CCT LED Wallpack Photocell	1600	72	120°	3000/4000K	30000
11354	220-240	22	Muro CCT LED Wallpack Emergency, Microwave Sensor	1600	72	120°	3000/4000K	30000
11355	220-240	22	Muro CCT LED Wallpack - Emergency, Photocell	1600	72	120°	3000/4000K	30000

Emergency versions must be tested in line with the requirements of BS5266, failure to do so may effect battery life and warranty.

<sup>1</sup> Exceeds EU standard of 70 for Lumens Maintenance Ratio  
<sup>2</sup> Exceeds EU standard of RA 70 for Colour Rendering Index  
<sup>3</sup> Subject to terms & conditions (Contact Customer Service)





## LED CCT Asymmetric Wallpack

Designed to be used where the aesthetics of the light fitting, along with a tough robust construction is needed. The fittings are IP66 and IK8 compliant, supplied complete with an opal diffuser for even light distribution. Available in Standard / Photocell / Emergency / Emergency Photocell versions.

- CCT 3/4/6000K
- Genuine replacement for 50W Metal Halide & Sodium
- TUV Certified Driver
- High impact polycarbonate lens
- 50% energy saving
- 50000 hours

### Options

- Standard / Photocell / Emergency / Emergency Photocell versions

25W  50W Energy Saving 50%



LMR80: Maximum 20% of lumen depreciation over rated hours.  
B10: Maximum 10% of fittings failure rate over rated hours



## LED CCT Asymmetric Wallpack

Code	V	W	Description	Lm	Lm/W	Temp	Hours
11500	240	25	Lumo LED CCT Asymmetric Wallpack	2875/3500/3250	115	3/4/6000K	50000
11501	240	25	Lumo LED CCT Asymmetric Wallpack Emergency	2875/3500/3250	115	3/4/6000K	50000
11502	240	25	Lumo LED CCT Asymmetric Wallpack Photocell	2875/3500/3250	115	3/4/6000K	50000
11503	240	25	Lumo LED CCT Asymmetric Wallpack Emergency Photocell	2875/3500/3250	115	3/4/6000K	50000

Emergency versions must be tested in line with the requirements of BS5266, failure to do so may effect battery life and warranty.



## LED CCT Asymmetric Wallpack

Technical Specification	
Construction	Aluminium Base Polycarbonate Lens
Driver	BELL
LED Chip	Samsung
IP Rating	IP65
Operating Temp	-30°C to +35°C / Emergency version minimum temperature 0°C
Input Voltage	240V
Power Factor	> 0.9
CRI	80 - Exceeds EU standard of Ra 70 for Colour Rendering Index
LMR	80 - Exceeds EU standard of 70 for Lumens Maintenance Ratio

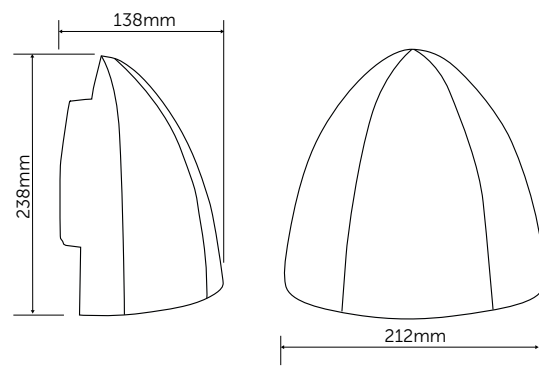

<sup>1</sup> Exceeds EU standard of 70 for Lumens Maintenance Ratio  
<sup>2</sup> Exceeds EU standard of RA 70 for Colour Rendering Index  
<sup>3</sup> Subject to terms & conditions (Contact Customer Service)





## LED Street Light

The Alto LED Street Light offers flexibility, it is suitable for use in many locations, including rural towns, car parks and access roads. The Alto is available in a variety of wattages for a variety of applications, and is a robust weatherproof construction meeting an IP66 protection rating.

- 150 lm/W
- Genuine Replacement for 70W Son or Metal Halide
- Ideal for car parks and pedestrian walkways
- Cool White
- Reduced light pollution
- Precision lens system directs light only where it is needed, reducing overspill
- Aerodynamic design for reduced windage
- 60mm side or post top entry
- 3 Pin Nema socket with blanking plug as standard



LMR80: Maximum 20% of lumen depreciation over rated hours.

B10: Maximum 10% of fittings failure rate over rated hours

	30W	50W	75W	100W	150W
Length (mm)	SE 523 / PTE 409	SE 523 / PTE 409	SE 629 / PTE 515	SE 629 / PTE 515	SE 724 / PTE 610
Width (mm)	SE 146 / PTE 146	SE 146 / PTE 146	SE 174 / PTE 174	SE 174 / PTE 174	SE 194 / PTE 194
Height (mm)	SE 134 / PTE 248	SE 134 / PTE 248	SE 135 / PTE 249	SE 135 / PTE 249	SE 137 / PTE 251

SE Side Entry  
PTE Post Top Entry

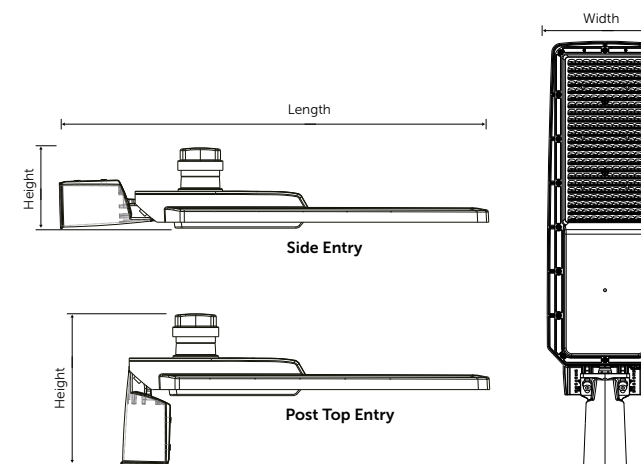



# LED Street Light

## Technical Specification

Construction	Die Cast Marine Grade Aluminium, polycarbonate lens
Driver	Sosen
LED Chip	Samsung
IP Rating	IP66
Operating Temp	-30°C to +35°C
Input Voltage	220-240V
Power Factor	> 0.9
CRI	80 - Exceeds EU standard of Ra 70 for Colour Rendering Index
LMR	80 - Exceeds EU standard of 70 for Lumens Maintenance Ratio
Weight	30W 1.5 Kg / 50W 1.5 Kg / 75W 2.4 Kg / 100W 2.4 Kg / 150W 3.3 Kg /
Windage	50W & 30W 0.06M <sup>2</sup> / 75W & 100W 0.09M <sup>2</sup> / 150W 0.12M <sup>2</sup>

Code	V	W	Lm	Description	Temp	Hours
11700	220-240	30	4500	Alto LED Street Light - IP66, Nema Socket	4000K	50000
11701	220-240	50	7500	Alto LED Street Light - IP66, Nema Socket	4000K	50000
11702	220-240	75	11250	Alto LED Street Light - IP66, Nema Socket	4000K	50000
11703	220-240	100	15000	Alto LED Street Light - IP66, Nema Socket	4000K	50000
11704	220-240	150	22500	Alto LED Street Light - IP66, Nema Socket	4000K	50000
31139	-	-	-	Photocell for above Street Lights		
11705	-	-	-	76mm Spigot for Alto LED Street Light		
90494	-	-	-	Alto 200mm outreach arm bracket (single) Fits Ø76mm column TE	-	-
90495	-	-	-	Alto 200mm outreach arm bracket (double) Fits Ø76mm column TE	-	-
90579	-	-	-	Alto wall mounting bracket	-	-

Index



<sup>1</sup> Exceeds EU standard of 70 for Lumens Maintenance Ratio  
<sup>2</sup> Exceeds EU standard of RA 70 for Colour Rendering Index  
<sup>3</sup> Subject to terms & conditions (Contact Customer Service)





## Outdoor Wall/Spike Garden Lights

The Luna Outdoor Wall & Spike Lights offer a universal solution ideal for domestic applications. Available in different colour options, the Luna range is ideal for decorative and accent lighting on properties of all shapes and sizes.

- Stainless Steel (black version - powder coated die-cast aluminium)
- Compatible with GU10 LED and Halogen lamps
- Spiked garden light ideal for highlighting garden ornaments, trees and shrubs
- Creates warm, welcoming atmosphere to your outside space
- Fixed single or twin wall-lights ideal for exterior feature lighting
- Dimmable when used with suitable lamp
- PIR options available (with over-ride function)



Use with BELL GU10's for optimum light performance



3.2W LED Halo GU10.  
Ideal for all applications.  
Available in 4 colour  
temperatures, dimmable and  
non-dimmable.



4.2W LED Halo Elite Glass GU10.  
High lumen output with halogen  
look.  
Available in 3 colour temperatures,  
dimmable and non-dimmable.

See LED GU10 lamps section for further details





## Outdoor Wall/Spike Garden Lights



Lamps Not Included

<sup>1</sup> Exceeds EU standard of 70 for Lumens Maintenance Ratio  
<sup>2</sup> Exceeds EU standard of RA 70 for Colour Rendering Index  
<sup>3</sup> Subject to terms & conditions (Contact Customer Service)



## Outdoor Wall/Spike Garden Lights

### Technical Specification

Construction	Powder Black Coated Aluminium / Stainless Steel
IP Rating	IP65/IP44
Input Voltage	220-240
Operating Temp	-30°C to +35°C
Lampholder	GU10

Code	Volts	Lamp	Description	Height	Depth
10336	220-240	GU10	Luna GU10 Wall Light - Fixed Single, S/Steel, IP65	120mm	85mm
10337	220-240	GU10	Luna GU10 Wall Light - Fixed Single, Black, IP65	112mm	92.5mm
10420	220-240	GU10	Luna GU10 Wall Light - Fixed PIR, S/Steel, IP44	183mm	112mm
10421	220-240	GU10	Luna GU10 Wall Light - Fixed PIR, Black, IP44	183mm	112mm
10338	220-240	GU10	Luna GU10 Wall Light - Fixed Up/Down, S/Steel, IP65	161mm	85mm
10339	220-240	GU10	Luna GU10 Wall Light - Fixed Up/Down, Black, IP65	161mm	85mm
10422	220-240	GU10	Luna GU10 Wall Light - Fixed Up/Down PIR, S/Steel, IP44	221mm	112mm
10423	220-240	GU10	Luna GU10 Wall Light - Fixed Up/Down PIR, Black, IP44	221mm	112mm
10340	220-240	GU10	Luna GU10 Wall Light - Adjustable, S/Steel, IP65	165mm	92mm
10341	220-240	GU10	Luna GU10 Wall Light - Adjustable, Black, IP65	155mm	90mm
10342	220-240	GU10	Luna GU10 LED Garden Spike - S/Steel, IP65	150mm	100mm
10343	220-240	GU10	Luna GU10 LED Garden Spike - Black, IP65	150mm	100mm





Index





## Grande Outdoor Wall Light

The Luna Grande Outdoor Wall Light combines aesthetics with an industrial feel. The largest up/down light in the BELL range features a frosted diffuser to emit a soft, welcoming light.

- Die-cast aluminium construction for durability and strength
- Compatible with GU10 LED and Halogen lamps
- Large size 265mm (height) x 145mm (depth) x Ø90mm
- Creates warm, welcoming atmosphere to your outside space
- Dimmable when used with suitable lamp
- Features a frosted diffuser to emit a soft directional light



Use with BELL GU10's for optimum light performance



3.2W LED Halo GU10.  
Ideal for all applications.  
Available in 4 colour  
temperatures, dimmable and  
non-dimmable.



4.2W LED Halo Elite Glass GU10.  
High lumen output with halogen  
look.  
Available in 3 colour temperatures,  
dimmable and non-dimmable.

See LED GU10 lamps section for further details





# Grande Outdoor Wall Light

Technical Specification	
Construction	Powder Coated Aluminium
IP Rating	IP65
Input Voltage	220-240
Operating Temp	-30°C to +35°C
Lampholder	GU10

Code	Volts	Lampholder	Description
10424	220-240	GU10	Luna Grande GU10 Wall Light - Fixed Up/Down, Black, IP65
10425	220-240	GU10	Luna Grande GU10 Wall Light - Fixed Up/Down, Grey, IP65



<sup>1</sup> Exceeds EU standard of 70 for Lumens Maintenance Ratio  
<sup>2</sup> Exceeds EU standard of Ra 80 for Colour Rendering Index  
<sup>3</sup> Subject to terms & conditions (Contact Customer Service)





## Retro

### Vintage Lantern

The Retro Vintage Lantern is manufactured from vandal resistant polycarbonate. Ideal for installation close to doors and entrances to provide a welcoming glow for visitors. Available in PIR and Non PIR versions, use a BELL LED photocell or standard lamp for best performance.

- Clear glazing for use with BELL ES/E27 Vintage and Soft Coil Lamps
- PIR versions available
- Manufactured from vandal resistant polycarbonate
- Tough, weather resistant IP54 construction
- Traditional, elegant designs
- Install close to doorways to optimise illumination for entrance areas
- 90° PIR detection area to minimise nuisance activations (PIR Versions)
- Suitable for coastal areas



#### Use with BELL Photocell Vintage and Soft Coil Lamps



LED Technology with the elegance of Incandescent Lamps

- Ideal replacement for Incandescent Lamps
- Creates a welcoming atmosphere
- Smooth dimming on rotary and digital dimming systems
- Quartz Filament on Vintage and Filament lamps
- Amber Glass Coating for decorative vintage look on vintage lamps
- Over 90% Energy Saving compared to incandescent lamps
- Super low energy consumption

See LED lamps section for further details



# Retro

## Vintage Lantern

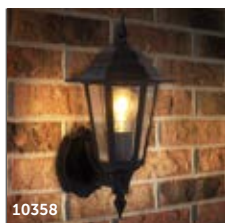

10358



10360

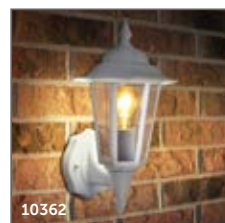

10362



10364

Version	Height	Depth	Width
Retro Lantern	375mm	230mm	177mm
Retro Half Lantern	362mm	99mm	175mm

Technical Specification	
Construction	Polycarbonate
IP Rating	IP54
Input Voltage	220-240V
Operating Temp	-30°C to +35°C
Lampholder	ES/E27

Code	Volts	W	Lampholder	Lm	Hrs	Description
10358	220 - 240	-	ES/E27	-	-	Retro Lantern Black (lamp not included)
10359	220 - 240	-	ES/E27	-	-	Retro Lantern Black with PIR (lamp not included)
10360	220 - 240	-	ES/E27	-	-	Retro Half Lantern Black (lamp not included)
10361	220 - 240	-	ES/E27	-	-	Retro Half Lantern Black with PIR (lamp not included)
10362	220 - 240	-	ES/E27	-	-	Retro Lantern White (lamp not included)
10363	220 - 240	-	ES/E27	-	-	Retro Lantern White with PIR (lamp not included)
10364	220 - 240	-	ES/E27	-	-	Retro Half Lantern White (lamp not included)
10365	220 - 240	-	ES/E27	-	-	Retro Half Lantern White with PIR (lamp not included)
10366	-	-	-	-	-	Universal Black Corner Bracket for Retro Vintage ES Lanterns
10367	-	-	-	-	-	Universal White Corner Bracket for Retro Vintage ES Lanterns







[technical@belllighting.co.uk](mailto:technical@belllighting.co.uk)  
[sales@belllighting.co.uk](mailto:sales@belllighting.co.uk)





Index



# Illuminaatlas

## Switchable Wattage LED High Bay

The Illumina Atlas Switchable Wattage High Bay is a highly efficient versatile LED luminaire, ideally suited to a wide range of industrial applications for both new installations and retrofit applications.

- 60-200 Switchable Wattages
- Seoul Semiconductor LED
- Plug-in PIR & Microwave sensors available
- Supplied with 1.5m flex
- Sensor parameters set by remote control
- Genuine Replacement for 250-600W Metal Halide or Sodium
- Perfect for warehousing, large retail and factories
- Emergency kit available
- 145 Lm/W

100W $\approx$ 250W MH/SON Energy Saving 60%	150W $\approx$ 400W MH/SON Energy Saving 63%	200W $\approx$ 600W MH/SON Energy Saving 66%
--	--	--

Quality Assured Product Warranty 7 YEAR	On Site Warranty 2 YEAR	Lumens Maintenance Rate 80 B10	Colour Rendering Index 85	Water & Dust Protection IP65 Fitting	Surge Protected 4000 Volts	Impact Rating IK10	Contact Us For SLL Standard Lighting Design	Grounding Symbol
---	-------------------------	--------------------------------	---------------------------	--------------------------------------	----------------------------	--------------------	---	------------------

LMR80: Maximum 20% of lumen depreciation over rated hours.  
 B10: Maximum 10% of fittings failure rate over rated hours

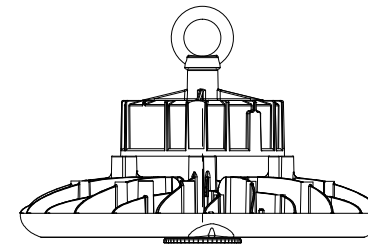

	100W	150W	200W
Diameter	245mm	245mm	294mm
Height	159mm	174mm	174mm



## Switchable Wattage LED High Bay

### Technical Specification

Construction	Die Cast Aluminium Body, Polycarbonate Lens
Driver	Muso 1-10V Dimmable as standard
LED Chip	Seoul Semiconductor
IP Rating	IP65
Operating Temp	-30°C to +50°C / Emergency version minimum temperature -5°C
Input Voltage	220 - 240V
Power Factor	> 0.9
CRI	85 - Exceeds EU standard of Ra 70 for Colour Rendering Index
LMR	80 - Exceeds EU standard of 70 for Lumens Maintenance Ratio
Weight	60-100W 2Kg / 90-150W 2.1Kg / 120-200W 2.8Kg

Code	W	Description	Lm	Temp	Hours
11450	60-100	Illumina Atlas Switchable Wattage LED High Bay 120° lens	9000-14000	4000K	50000
11452	90-150	Illumina Atlas Switchable Wattage LED High Bay 120° lens	14000-21000	4000K	50000
11454	120-200	Illumina Atlas Switchable Wattage LED High Bay 120° lens	18000-28000	4000K	50000
11451	60-100	Illumina Atlas Switchable Wattage LED High Bay 90° lens	9000-14000	4000K	50000
11453	90-150	Illumina Atlas Switchable Wattage LED High Bay 90° lens	14000-21000	4000K	50000
11455	120-200	Illumina Atlas Switchable Wattage LED High Bay 90° lens	18000-28000	4000K	50000
11478	-	Plug In Emergency Pack	-	-	-
11463	-	Twist Microwave Sensor for Illumina Atlas Switchable Wattage High Bay	-	-	-
11464	-	Twist PIR Sensor for Illumina Atlas Switchable Wattage High Bay	-	-	-
11465	-	Casambi Bluetooth Wireless Node for Illumina Atlas Switchable Wattage High Bay	-	-	-
11471	-	Polycarbonate Reflector for 60/70/100W and 90/120/150W Illumina Atlas Switchable Wattage High Bay	-	-	-
11472	-	Polycarbonate Reflector for 120/160/200W Illumina Atlas Switchable Wattage High Bay	-	-	-
11473	-	Aluminium Reflector for 60/70/100W and 90/120/150W Illumina Atlas Switchable Wattage High Bay	-	-	-
11474	-	Aluminium Reflector for 120/160/200W Illumina Atlas Switchable Wattage High Bay	-	-	-
11475	-	Reflector Cover for 60/70/100W and 90/120/150W Illumina Atlas Switchable Wattage High Bay	-	-	-
11476	-	Reflector Cover for 120/160/200W Illumina Atlas Switchable Wattage High Bay	-	-	-
11477	-	60° Adjustable Bracket for Illumina Atlas Switchable Wattage High Bay	-	-	-
11466	-	Infra-red remote control	-	-	-



Optional infra-red remote control available for PIR & microwave sensor versions.

Quick and easy adjustment for multiple fittings; dimming level, presence detection, light levels & automatic on-off time. Average 15M range.

<sup>1</sup> Exceeds EU standard of 70 for Lumens Maintenance Ratio  
<sup>2</sup> Exceeds EU standard of RA 70 for Colour Rendering Index  
<sup>3</sup> Subject to terms & conditions (Contact Customer Service)





# Illuminaslim elite

## LED High Bay

The Illumina Slim Elite luminaire is our most efficient High Bay. A versatile LED fitting, ideally suited to a wide range of industrial applications for both new installations and retrofit applications.

- Switchable wattage option available
- TUV Driver
- Seoul Semiconductor LED
- 90° & 120° lens options
- Integrated microwave sensor versions available
- Sensor parameters set by remote control
- Up to 200 lm/W
- Genuine Replacement for 400W/600W/1000W Metal Halide or Sodium
- Cool White 4000K
- High CRI Ra85
- Perfect for warehousing, large retail and factories

100W  $\equiv$  400 W MH/SON Energy Saving 75%    150W  $\equiv$  600 W MH/SON Energy Saving 75%    200W  $\equiv$  1000 W MH/SON Energy Saving 80%

LMR80: Maximum 20% of lumen depreciation over rated hours.  
 B10: Maximum 10% of fittings failure rate over rated hours

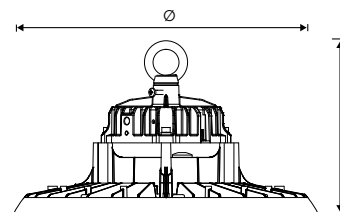

	100W	150/200W
Ø	293mm	364mm
H	167mm	167mm

# Illuminaslim elite

## LED High Bay

### Technical Specification

Construction	Die Cast Aluminium
Driver	LiFud
LED Chip	Seoul Semiconductor
IP Rating	IP65
Operating Temp	-30°C to +35°C / Emergency version minimum temperature -5°C
Input Voltage	220 - 240V
Power Factor	> 0.9
CRI	85 - Exceeds EU standard of Ra 70 for Colour Rendering Index
LMR	80 - Exceeds EU standard of 70 for Lumens Maintenance Ratio
Weight	100W 1.6Kg / Switchable 2.9Kg

Code	W	Description	Lm	Temp	Hours
08885	100	100W Illumina Slim Elite LED High Bay, 120° Lens	19000	4000K	50000
08886	100	100W Illumina Slim Elite LED High Bay, 90° Lens	19000	4000K	50000
08887	100	100W Illumina Slim Elite LED High Bay Emergency, 120° Lens	19000	4000K	50000
08888	100	100W Illumina Slim Elite LED High Bay Emergency, 90° Lens	19000	4000K	50000
08889	150/200	150W-200W Illumina Slim Switchable Elite LED High Bay, 120° Lens	30000/39200	4000K	50000
08890	150/200	150W-200W Illumina Slim Switchable Elite LED High Bay, 90° Lens	30000/39200	4000K	50000
08891	150/200	150W-200W Illumina Slim Switchable Elite LED High Bay Emergency, 120° Lens	30000/39200	4000K	50000
08892	150/200	150W-200W Illumina Slim Switchable Elite LED High Bay, Emergency, 90° Lens	30000/39200	4000K	50000

<sup>1</sup> Exceeds EU standard of 70 for Lumens Maintenance Ratio

<sup>2</sup> Exceeds EU standard of RA 70 for Colour Rendering Index

<sup>3</sup> Subject to terms & conditions (Contact Customer Service)







# Illuminamuto

## Switchable Wattage LED High Bay

The Illumina Muto is our most cost-effective LED High Bay to date. Perfect for all warehouses and factories of any size due to its wattage switchable functionality. This genuine replacement for Metal Halide or Sodium lighting offers up to 120 lumens per watt and a 3-year warranty.

- 100/150/200 & 100/120/150 Wattage Switchable & 100W fixed versions
- Up to 120 lm/W
- Genuine Replacement for 150/250/400W Metal Halide or Sodium
- Cool White 4000K
- Perfect for warehousing, large retail and factories
- 120° Beam Angle
- Fixed bracket option available

100W $\equiv$ 150W MH/SON Energy Saving 33%	150W $\equiv$ 250W MH/SON Energy Saving 40%	200W $\equiv$ 400W MH/SON Energy Saving 50%
---	---	---

Quality Assured 3 YEAR Product Warranty	Lumens Maintenance Ratio 80 B10	Colour Rendering Index 85	Water & Dust Protection IP65 Fitting	Impact IK8 Rating	Contact Us For SLL Standard Lighting Design	Grounding Symbol
---	---------------------------------------	------------------------------	--	-------------------------	--	------------------

LMR80: Maximum 20% of lumen depreciation over rated hours.  
B10: Maximum 10% of fittings failure rate over rated hours

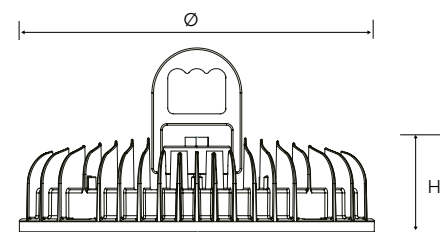

	100/150/200W	100/120/150W	100W
Ø	300mm	260mm	220mm
H	60mm	60mm	60mm



# Illuminamuto

## Switchable Wattage LED High Bay

### Technical Specification

Construction	Die Cast Aluminium
Driver	DOB
LED Chip	Seoul Semiconductor
IP Rating	IP65
Operating Temp	-30°C to +35°C
Input Voltage	220 - 240V
Power Factor	> 0.9
CRI	85 - Exceeds EU standard of Ra 70 for Colour Rendering Index
LMR	80 - Exceeds EU standard of 70 for Lumens Maintenance Ratio
Weight	08945 2.9Kg / 08946 2.0Kg / 11360 1.6Kg

Code	W	Description	Lm	Temp	Hours
08945	100/150/200	100-200W Illumina Muto Switchable Wattage LED High Bay	12000/18000/24000	4000K	30000
08946	100/120/150	100-150W Illumina Muto Switchable Wattage LED High Bay	11500/13800/17250	4000K	30000
11360	100	100W Illumina Muto LED High Bay	11000	4000K	30000
08947	-	Mounting Bracket for above	-	-	-

<sup>1</sup> Exceeds EU standard of 70 for Lumens Maintenance Ratio  
<sup>2</sup> Exceeds EU standard of RA 70 for Colour Rendering Index  
<sup>3</sup> Subject to terms & conditions (Contact Customer Service)





# Illuminacalor

## LED High Bay

The Illumina Calor offers a sleek design coupled with high performance. With a high ambient temperature rating of 65°C, this fitting is perfect for applications where extreme high temperatures are encountered eg; foundries, steelworks and bottling plants.

- Philips Isolated Driver
- 1-10V dimming as standard
- Philips Lumileds LED
- Sensor versions available
- Sensor parameters can be set by optional remote control (sensor versions)
- High ambient temperature version 65°C
- Genuine Replacement for 250W/400W/600W Metal Halide or Sodium

100W $\equiv$ 250W MH/SON Energy Saving 60%	150W $\equiv$ 400W MH/SON Energy Saving 63%	200W $\equiv$ 600W MH/SON Energy Saving 66%
---	---	---

Quality Assured Product Warranty 7 YEAR	On Site 2 YEAR Warranty	Lumen Maintenance Ratio B10 80	Colour Rendering Index 85	Water & Dust Protection Fitting IP65	Surge Protected 4000 Volts	Impact Rating IK8	Contact Us for Lighting Design SLL Standard	Earth Symbol
---	-------------------------	--------------------------------	---------------------------	--------------------------------------	----------------------------	-------------------	---	--------------

LMR80: Maximum 20% of lumen depreciation over rated hours.  
 B10: Maximum 10% of fittings failure rate over rated hours

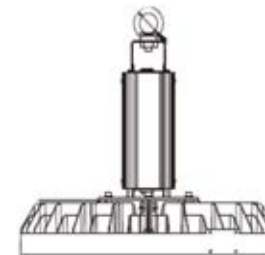

	100W	150W	200W
Diameter	360mm	360mm	360mm
Height	309mm	309mm	387mm



# illuminacalor

## LED High Bay

### Technical Specification

Construction	Die Cast Aluminium
Driver	Philips High Temperature Driver
LED Chip	Philips Lumileds
IP Rating	IP65
Operating Temp	-30°C to +65°C
Input Voltage	220 - 240V
Power Factor	> 0.9
CRI	85 - Exceeds EU standard of Ra 70 for Colour Rendering Index
LMR	80 - Exceeds EU standard of 70 for Lumens Maintenance Ratio
Weight	100W 3.90Kg / 150W 3.90Kg / 200W 4.30kg

Code	W	Description	Lm	Temp	Hours
10900	100	Illumina Calor 100W LED Highbay 120° lens	14000	4000K	50000
10901	100	Illumina Calor 100W LED Highbay 90° lens	14000	4000K	50000
10902	150	Illumina Calor 150W LED Highbay 120° lens	21000	4000K	50000
10903	150	Illumina Calor 150W LED Highbay 90° lens	21000	4000K	50000
10904	200	Illumina Calor 200W LED Highbay 120° lens	28000	4000K	50000
10905	200	Illumina Calor 200W LED Highbay 90° lens	28000	4000K	50000
10913	-	Aluminium Reflector	-	-	-

<sup>1</sup> Exceeds EU standard of 70 for Lumens Maintenance Ratio  
<sup>2</sup> Exceeds EU standard of RA 70 for Colour Rendering Index  
<sup>3</sup> Subject to terms & conditions (Contact Customer Service)

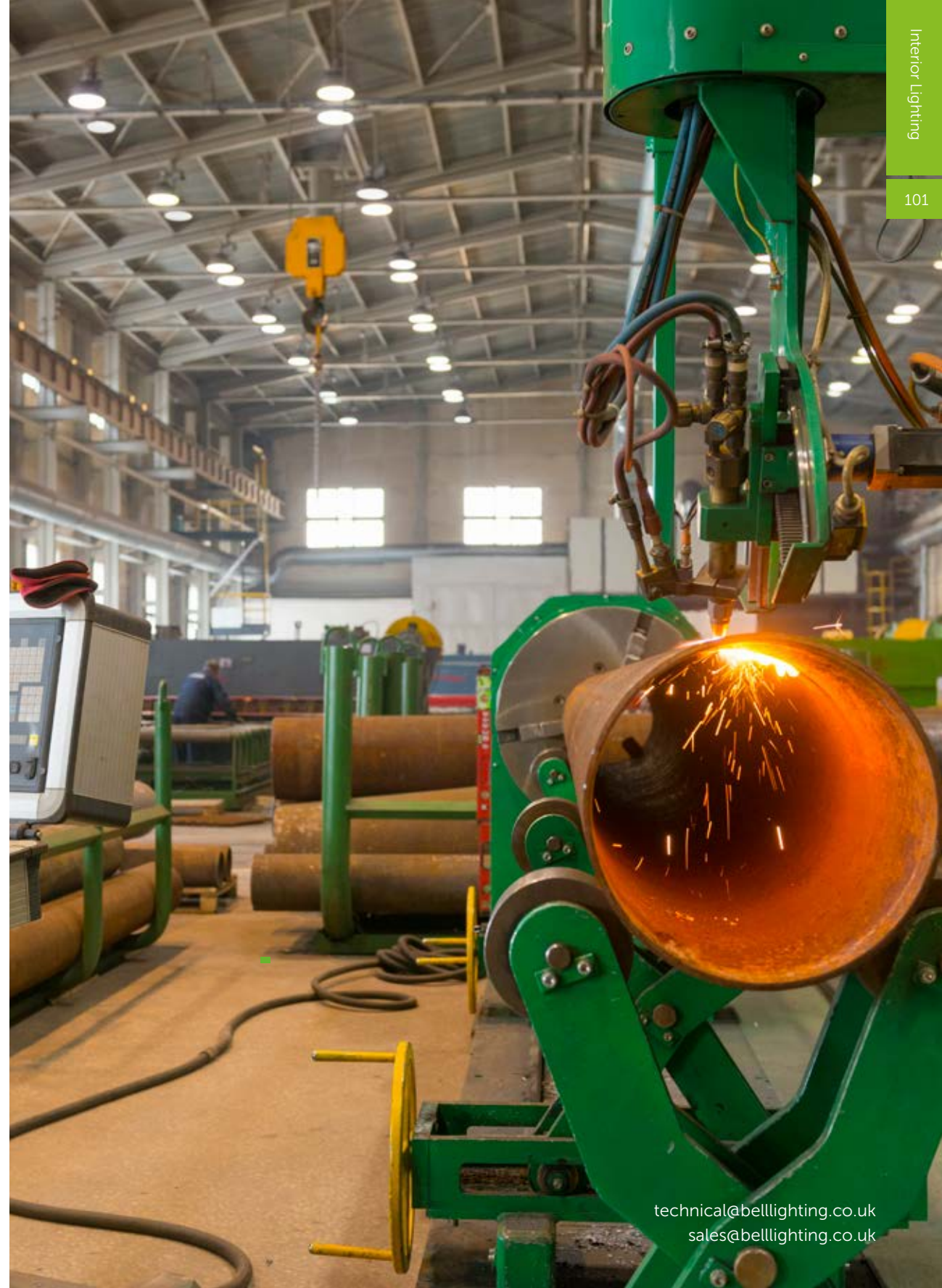





# IlluminaLinear

## LED High Intensity High/Low Bay

The Illumina Linear offers a sleek design coupled with high performance. Perfect for high ceiling warehouses, industrial facilities, exhibition centres, shopping malls & stadiums.

- Genuine replacement for 400W Metal Halide
- Perfect for racking, warehouse, large retail and factories
- TUV Isolated Driver
- 1-10V dimming as standard
- Suitable for High Bay and Low Bay applications 4-12m
- Built-in adjustable motion sensor (sensor versions)
- Sensor parameters set by remote control
- High efficiency up to 130Lm/w
- Specially designed for warehouse aisles with the fitting's rectangular lighting patterns
- Long and narrow patterns not only contribute to lighting lux levels but also give improved uniformity
- Emergency options available
- Self Test options available

200W  $\equiv$  400W MH/SON Energy Saving 50%



LMR80: Maximum 20% of lumen depreciation over rated hours.  
B10: Maximum 10% of fittings failure rate over rated hours



## LED High Intensity High/Low Bay

### Technical Specification

Construction	Extruded Aluminium
Driver	Sosen
LED Chip	Seoul
IP Rating	IP65
Operating Temp	-30°C to +35°C / Emergency version minimum temperature -5°C
Input Voltage	110-264V
Power Factor	> 0.9
CRI	85 - Exceeds EU standard of Ra 70 for Colour Rendering Index
LMR	80 - Exceeds EU standard of 70 for Lumens Maintenance Ratio
Weight	7.0Kg

Code	W	Description	Lm	Temp	Hours
08950	200	200W Illumina Linear High Rack 30x70°	26000	4000K	50000
08951	200	200W Illumina Linear Low Rack 40x120°	26000	4000K	50000
08952	200	200W Illumina Linear High Open Area 90°	26000	4000K	50000
08953	200	200W Illumina Linear Low Open Area 120°	26000	4000K	50000
08954	200	200W Illumina Linear High Rack & Sensor 30x70°	26000	4000K	50000
08955	200	200W Illumina Linear Low Rack & Sensor 40x120°	26000	4000K	50000
08956	200	200W Illumina Linear High Open Area & Sensor 90°	26000	4000K	50000
08957	200	200W Illumina Linear Low Open Area & Sensor 120°	26000	4000K	50000
06772	-	Remote Control for above sensor versions (corridor dim only)	-	-	-



Optional infra-red remote control available for microwave sensor versions.

Quick and easy adjustment for multiple fittings; dimming level, presence detection, light levels & automatic on-off time. Average 15M range

<sup>1</sup> Exceeds EU standard of 70 for Lumens Maintenance Ratio  
<sup>2</sup> Exceeds EU standard of RA 80 for Colour Rendering Index  
<sup>3</sup> Subject to terms & conditions (Contact Customer Service)

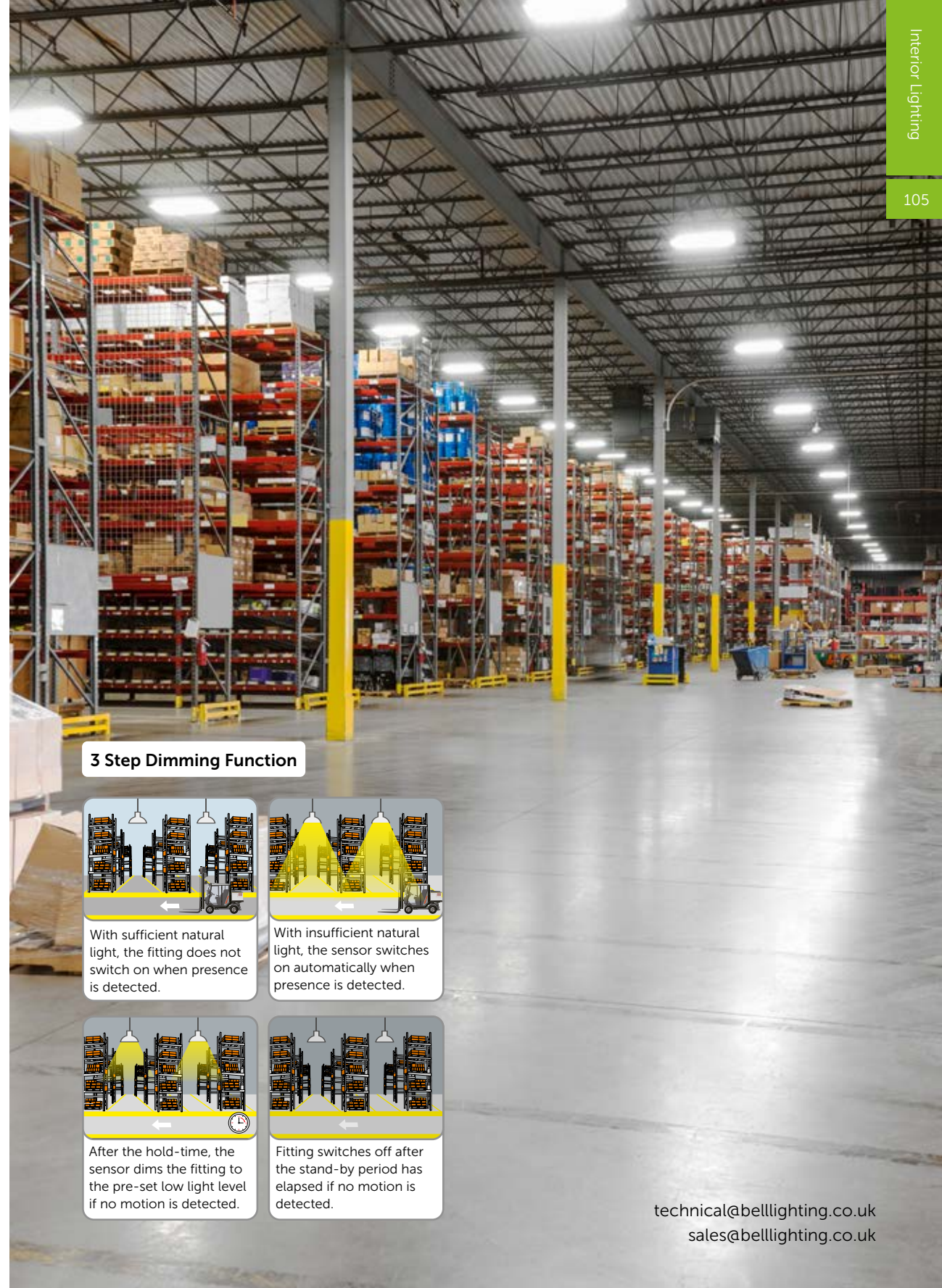

### 3 Step Dimming Function

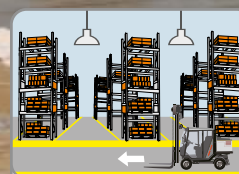

With sufficient natural light, the fitting does not switch on when presence is detected.

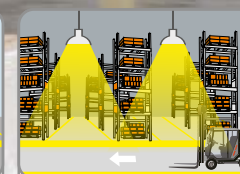

With insufficient natural light, the sensor switches on automatically when presence is detected.

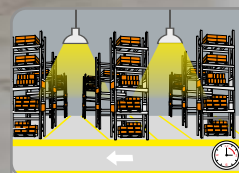

After the hold-time, the sensor dims the fitting to the pre-set low light level if no motion is detected.

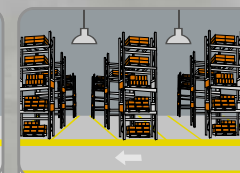

Fitting switches off after the stand-by period has elapsed if no motion is detected.



# lluminaLinear

## LED High Intensity UGR<20 High/Low Bay

The Illumina Linear offers a sleek design coupled with high performance. Perfect for high ceiling warehouses, industrial facilities, exhibition centres, shopping malls, sports halls & stadiums.

- Genuine replacement for up to 400W Metal Halide
- Perfect for sports halls, tennis, badminton, cricket
- TUV Isolated Driver
- Suitable for High Bay and Low Bay applications 4-12m
- Plug-in PIR and Microwave sensors
- Sensor parameters set by remote control
- High efficiency 140Lm/w
- Specially designed for low glare sports and warehouse lighting
- Emergency options available
- Self Test options available

50W  $\approx$  100W MH/SON Energy Saving 50%    100W  $\approx$  250W MH/SON Energy Saving 60%    200W  $\approx$  400W MH/SON Energy Saving 50%



LMR80: Maximum 20% of lumen depreciation over rated hours.

B10: Maximum 10% of fittings failure rate over rated hours

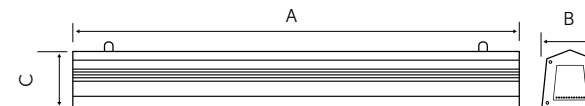

	50W	100W	200W
A	429mm	717mm	1293mm
B	118mm	118mm	118mm
C	113mm	113mm	113mm



## LED High Intensity UGR<20 High/Low Bay

### Technical Specification

Construction	Aluminium
Driver	Sosen
LED Chip	Seoul
IP Rating	IP65
Operating Temp	-30°C to +45°C / Emergency version minimum temperature -5°C
Input Voltage	110-264V
Power Factor	> 0.9
CRI	85 - Exceeds EU standard of Ra 70 for Colour Rendering Index
LMR	80 - Exceeds EU standard of 70 for Lumens Maintenance Ratio
Weight	50W 2.3Kg / 100W 4.1Kg / 150W 5.83Kg / 200W 7.4Kg

Code	W	Description	Lm	Temp	Hours
11300	50	Illumina Linear UGR LED High Bay - Asymmetric	7000	4000K	50000
11301	50	Illumina Linear UGR LED High Bay - Symmetric	7000	4000K	50000
11302	50	Illumina Linear UGR LED High Bay - Emergency, Asymmetric	7000	4000K	50000
11303	50	Illumina Linear UGR LED High Bay - Emergency, Symmetric	7000	4000K	50000
11306	100	Illumina Linear UGR LED High Bay - Asymmetric	14000	4000K	50000
11307	100	Illumina Linear UGR LED High Bay - Symmetric	14000	4000K	50000
11308	100	Illumina Linear UGR LED High Bay - Emergency, Asymmetric	14000	4000K	50000
11309	100	Illumina Linear UGR LED High Bay - Emergency, Symmetric	14000	4000K	50000
11318	200	Illumina Linear UGR LED High Bay - Asymmetric,	28000	4000K	50000
11319	200	Illumina Linear UGR LED High Bay - Symmetric	28000	4000K	50000
11320	200	Illumina Linear UGR LED High Bay - Emergency, Asymmetric	28000	4000K	50000
11321	200	Illumina Linear UGR LED High Bay - Emergency, Symmetric	28000	4000K	50000
08992	-	PIR for Illumina Linear UGR LED High Bay	-	-	-
08993	-	Microwave Sensor for Illumina Linear UGR LED High Bay	-	-	-
11324	-	Suspension Kit for Illumina Linear UGR LED High Bay	-	-	-
11325	-	60° Adjustable Bracket for Illumina Linear UGR LED High Bay	-	-	-
06772	-	Remote Control for above sensor versions	-	-	-

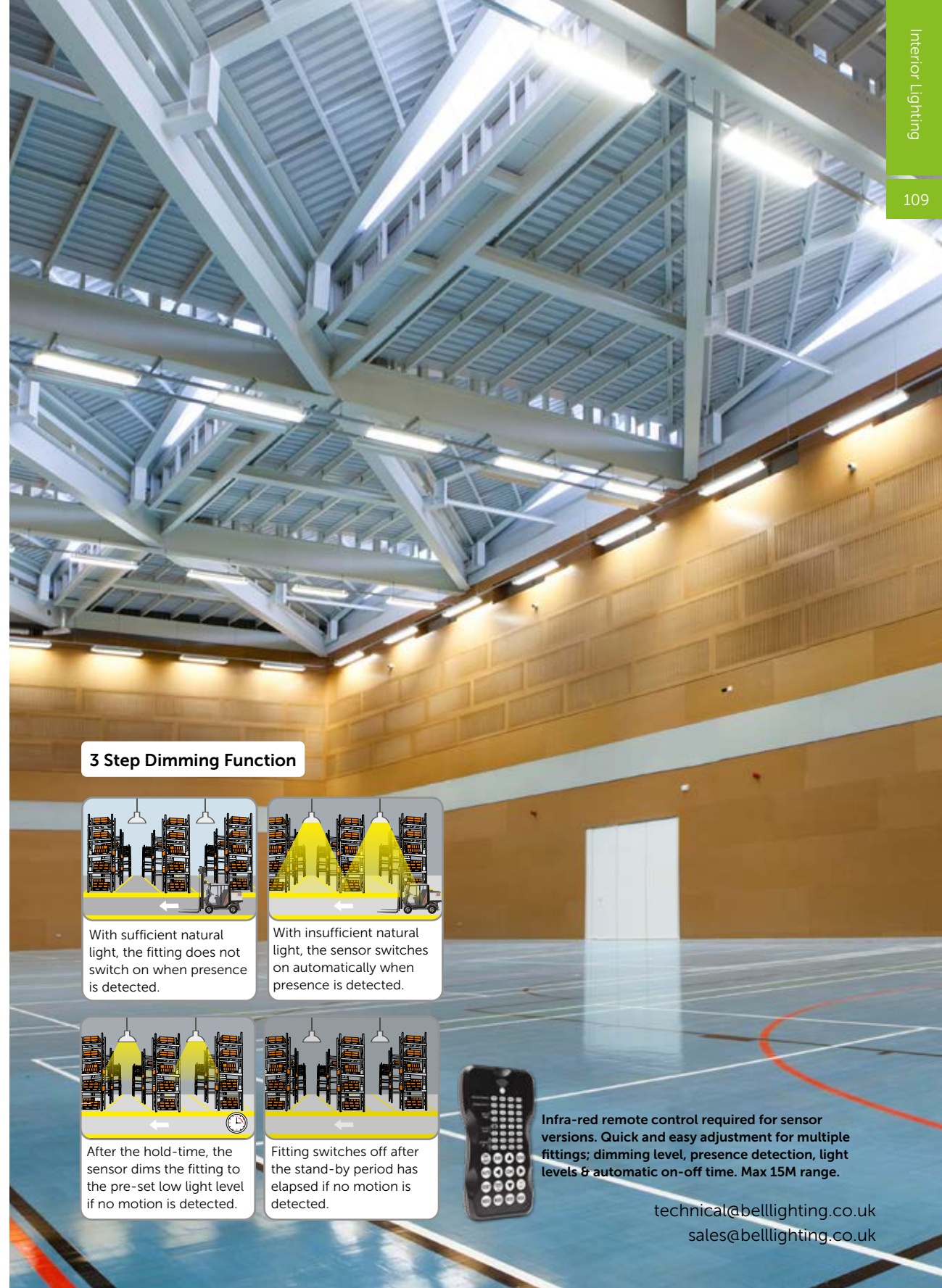

### 3 Step Dimming Function

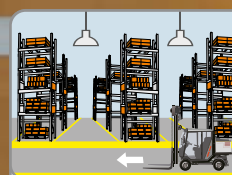

With sufficient natural light, the fitting does not switch on when presence is detected.

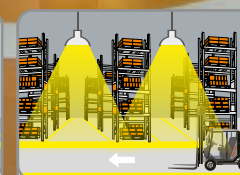

With insufficient natural light, the sensor switches on automatically when presence is detected.

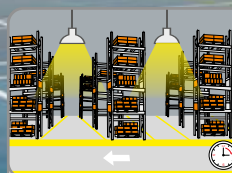

After the hold-time, the sensor dims the fitting to the pre-set low light level if no motion is detected.

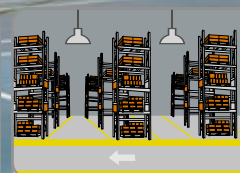

Fitting switches off after the stand-by period has elapsed if no motion is detected.



Infra-red remote control required for sensor versions. Quick and easy adjustment for multiple fittings; dimming level, presence detection, light levels & automatic on-off time. Max 15M range.



## LED Integrated Anti Corrosive Batten

The Dura LED Anti Corrosive Batten is one of BELL's flagship Luminaires. This fully enclosed luminaire comes with stainless steel diffuser clips, ideal for exterior lighting projects that are open to the elements.

- The ideal replacement for Single/Twin Fluorescent T8 and T5 Fixtures
- Injection moulded polycarbonate body - suitable for food environments
- Special high light transmission frosted polycarbonate diffuser for smooth uniform lighting
- Stainless steel clips & suspension brackets
- Tool-free termination
- Shatterproof
- Up to 140 Lm/W
- PIR versions available on request



**LMR80:** Maximum 20% of lumen depreciation over rated hours.

**B10:** Maximum 10% of fittings failure rate over rated hours

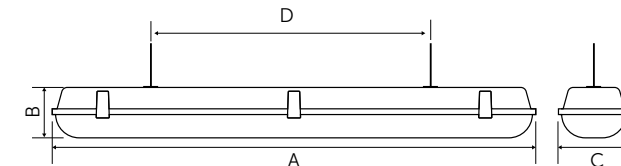

	A	B	C	D
10W 2' Batten	654mm	90mm	90mm	390-430mm
20W 2' Batten	654mm	90mm	125mm	390-430mm
20W 4' Batten	1263mm	90mm	90mm	900-955mm
40W 4' Batten	1263mm	90mm	125mm	900-955mm
25W 5' Batten	1530mm	90mm	90mm	1000-1055mm
52W 5' Batten	1530mm	90mm	125mm	1000-1055mm
28W 6' Batten	1828mm	90mm	90mm	1000-1055mm
60W 6' Batten	1828mm	90mm	125mm	1000-1055mm



## LED Integrated Anti Corrosive Batten

Technical Specification	
Construction	Polycarbonate Body & lens
Driver	BELL
LED Chip	Samsung
IP Rating	IP66
Operating Temp	-30°C to +35°C / Emergency version minimum temperature -5°C
Input Voltage	220 - 240V
Power Factor	> 0.9
CRI	85 - Exceeds EU standard of Ra 80 for Colour Rendering Index
LMR	80 - Exceeds EU standard of 70 for Lumens Maintenance Ratio
L1A / L1B / L2A / L2B Compliant	Yes

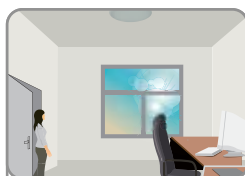

With sufficient natural light, the fitting does not switch on when presence is detected.

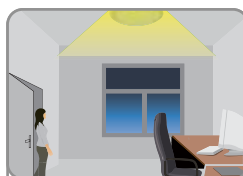

With insufficient natural light, the sensor switches on automatically when someone enters the room.



When the room is empty, light dims to stand-by level (10% / 20% / 30%) after the hold-time.

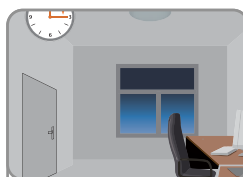

Light switched off automatically after the stand-by period has elapsed.

### Tri-Level Control (Corridor Function)



Optional infra-red remote control available for microwave sensor versions.

Quick and easy adjustment for multiple fittings; dimming level, presence detection, light levels & automatic on-off time. Average 4M range

Offers 3 levels of light: 100%-dimmed light (10%, 20%, 30%)-off; and 2 periods of selectable waiting time: motion hold-time and stand-by period; selectable daylight threshold and choice of detection area.

<sup>1</sup> Exceeds EU standard of 70 for Lumens Maintenance Ratio

<sup>2</sup> Exceeds EU standard of RA 80 for Colour Rendering Index

<sup>3</sup> Subject to terms & conditions (Contact Customer Service)

## LED Integrated Anti Corrosive Batten

Code	W	Description	Lm	Temp	Hours
10257	10	Dura Anti Corrosive Batten - Single 600mm (2ft)	1260	4000K	50000
10256	20	Dura Anti Corrosive Batten - Double 600mm (2ft)	2420	4000K	50000
10255	20	Dura Anti Corrosive Batten - Double Emergency 600mm (2ft)	2420	4000K	50000
06722	20	Dura Anti Corrosive Batten - Single 1200mm (4ft)	2700	4000K	50000
06723	20	Dura Anti Corrosive Batten - Single Emergency 1200mm (4ft)	2700	4000K	50000
06728	40	Dura Anti Corrosive Batten - Double 1200mm (4ft)	5550	4000K	50000
06729	40	Dura Anti Corrosive Batten - Double Emergency 1200mm (4ft)	5550	4000K	50000
06710	25	Dura Anti Corrosive Batten - Single 1500mm (5ft)	3430	4000K	50000
06711	25	Dura Anti Corrosive Batten - Single Emergency 1500mm (5ft)	3430	4000K	50000
06712	25	Dura Anti Corrosive Batten - Single with Microwave Sensor + Corridor Dim Function 1500mm (5ft)	3430	4000K	50000
06713	25	Dura Anti Corrosive Batten - Single Emergency with Microwave Sensor + Corridor Dim Function 1500mm (5ft)	3430	4000K	50000
06714	25	Dura Anti Corrosive Batten - Single with Microwave Sensor 1500mm (5ft)	3430	4000K	50000
06715	25	Dura Anti Corrosive Batten - Single Emergency with Microwave Sensor 1500mm (5ft)	3430	4000K	50000
06716	52	Dura Anti Corrosive Batten - Double 1500mm (5ft)	6850	4000K	50000
06717	52	Dura Anti Corrosive Batten - Double Emergency 1500mm (5ft)	6850	4000K	50000
06718	52	Dura Anti Corrosive Batten - Double with Microwave Sensor + Corridor Dim Function 1500mm (5ft)	6850	4000K	50000
06719	52	Dura Anti Corrosive Batten - Double Emergency / Microwave Sensor + Corridor Dim Function 1500mm (5ft)	6850	4000K	50000
06720	52	Dura Anti Corrosive Batten - Double with Microwave Sensor 1500mm (5ft)	6850	4000K	50000
06721	52	Dura Anti Corrosive Batten - Emergency with Microwave Sensor 1500mm (5ft)	6850	4000K	50000
06760	28	Dura Anti Corrosive Batten - Single 1800mm (6ft)	4050	4000K	50000
06761	28	Dura Anti Corrosive Batten - Single Emergency 1800mm (6ft)	4050	4000K	50000
06766	60	Dura Anti Corrosive Batten - Double 1800mm (6ft)	7790	4000K	50000
06767	60	Dura Anti Corrosive Batten - Double Emergency 1800mm (6ft)	7790	4000K	50000
06772	-	Remote Control for above sensor versions (corridor dim only)	-	-	-
08679	-	Batten Mount PIR	-	-	-
08673	-	Remote Control for above Batten Mount PIR on/off	-	-	-

**Microwave Max Operating Height 3.2m**

Emergency versions must be tested in line with the requirements of BS5266, failure to do so may effect battery life and warranty





#### Northern Ireland Water: BELL Dura LED Integrated Anti Corrosive Battens

Over the life of the fitting, Northern Ireland Water could save: £86,384 in energy costs, energy saving 46%

- Annual Energy Saving 54,787kWh
- Annual CO<sub>2</sub> Saving 25,750kg
- Annual Maintenance £9000



## LED Integrated CCT Anti Corrosive Batten

The Dura LED CCT Anti Corrosive Batten is part of one of BELL's flagship luminaire families. The Dura CCT combines the reliability of the Dura Batten with the added CCT & wattage switchable functionality. Plug in emergency packs, Microwave and PIR on/off sensors create a very stock friendly solution for wholesalers and contractors alike.

- The ideal replacement for Single/Twin Fluorescent T8 and T5 Fixtures
- Special high light transmission frosted polycarbonate diffuser for smooth uniform dimming
- Perfect for all commercial environments
- Tool-free termination
- Plug in accessories
- Stock friendly product
- Suitable for BESA Box mounting



LMR80: Maximum 20% of lumen depreciation over rated hours.  
 B10: Maximum 10% of fittings failure rate over rated hours

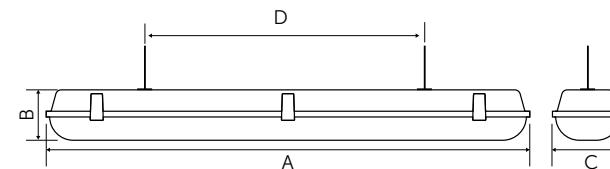

	A	B	C	D
20/40W 4' Batten	1263mm	90mm	90mm	900-955mm
25/50W 5' Batten	1530mm	90mm	90mm	1000-1055mm
30/60W 6' Batten	1828mm	90mm	90mm	1000-1055mm

W	Colour Temp (K) Selected	Lm
20	3000	2850
	4000	3000
	6000	2950
40	3000	5100
	4000	5550
	6000	5250
25	3000	3550
	4000	3800
	6000	3850
50	3000	6350
	4000	7000
	6000	6800
30	3000	4250
	4000	4500
	6000	4450
60	3000	7500
	4000	8150
	6000	7950



## LED Integrated CCT Anti Corrosive Batten

118

Technical Specification	
Construction	Polycarbonate Body & lens
Driver	BELL
LED Chip	Samsung
IP Rating	IP66
Operating Temp	-30°C to +35°C / Emergency version minimum temperature -5°C
Input Voltage	220 - 240V
Power Factor	> 0.9
CRI	85 - Exceeds EU standard of Ra 80 for Colour Rendering Index
LMR	80 - Exceeds EU standard of 70 for Lumens Maintenance Ratio
L1A / L1B / L2A / L2B Compliant	Yes

<sup>1</sup> Exceeds EU standard of 70 for Lumens Maintenance Ratio  
<sup>2</sup> Exceeds EU standard of RA 80 for Colour Rendering Index  
<sup>3</sup> Subject to terms & conditions (Contact Customer Service)



## LED Integrated CCT Anti Corrosive Batten

119

Code	W	Description	Lm	Temp	Hours
10275	20/40	Dura LED Anti Corrosive Batten - CCT, 1200mm (4ft)	2850-5550	3/4/6000K	50000
10276	25/50	Dura LED Anti Corrosive Batten - CCT, 1500mm (5ft)	3550-7000	3/4/6000K	50000
10277	30/60	Dura LED Anti Corrosive Batten - CCT, 1800mm (6ft)	4250-8150	3/4/6000K	50000
10281	-	Plug in Emergency Pack for CCT Battens	-	-	-
10282	-	Plug in Sensor On/Off for CCT Battens	-	-	-
10293	-	Plug in PIR for CCT Battens	-	-	-
10294	-	Remote Control for CCT Battens (PIR only)	-	-	-
91359	-	Plug In Self Test pack for CCT Battens	-	-	-

### PIR Max Operating Height 3.2m

Emergency versions must be tested in line with the requirements of BS5266, failure to do so may effect battery life and warranty





## LED Integrated CCT UGR<19 Batten

The Mentor Wattage Switchable LED integrated CCT Batten is colour selectable with a choice of 3000K, 4000K or 6000K to suit your application. 36 in 1 fitting with plug-in emergency packs, Microwave and PIR on/off sensors available, along with a Dali Dimming version.

- The ideal replacement for Single/Twin Fluorescent T8 and T5 Fixtures
- Perfect for schools, universities & hospitals where a flexible wattage, selectable colour batten is required
- Suitable for food environments
- Special high light transmission frosted polycarbonate diffuser for smooth uniform lighting with reduced glare
- Tool-free termination
- Shatterproof
- Up to 140 Lm/W

LMR80: Maximum 20% of lumen depreciation over rated hours.  
 B10: Maximum 10% of fittings failure rate over rated hours

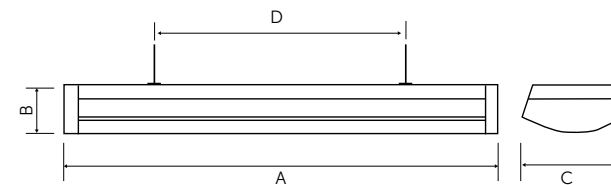

	A	B	C	D
4' Batten	1200mm	97mm	200mm	1000mm
5' Batten	1500mm	97mm	200mm	1300mm

W	Colour Temp (K) Selected	Lm
20	3000	2650
	4000	2800
	6000	2850
38	3000	4550
	4000	4800
	6000	4850
32 Dali Dim	3000	4100
	4000	4350
	6000	4400
42 Dali Dim	3000	5250
	4000	5550
	6000	5600
34	3000	4300
	4000	4550
	6000	4600
53	3000	6500
	4000	6900
	6000	6950
47 Dali Dim	3000	6100
	4000	6450
	6000	6500
55 Dali Dim	3000	7350
	4000	7800
	6000	7850



## LED Wattage Switchable, Integrated CCT Batten

Technical Specification	
Construction	Steel Body / Polycarbonate Diffuser
Driver	Tridonic
LED Chip	Samsung
IP Rating	IP40
Operating Temp	-30°C to +35°C / Emergency version minimum temperature -5°C
Input Voltage	220 - 240V
Power Factor	> 0.9
CRI	85 - Exceeds EU standard of Ra 80 for Colour Rendering Index
LMR	80 - Exceeds EU standard of 70 for Lumens Maintenance Ratio
L1A / L1B / L2A / L2B Compliant	Yes

Code	W	Description	Lm	Temp	Hours
10285	20/38	Mentor Wattage Switchable LED Batten CCT, 1200mm (4ft)	2650-4850	3/4/6000K	50000
10286	34/53	Mentor Wattage Switchable LED Batten CCT, 1500mm (5ft)	4300-6950	3/4/6000K	50000
10287	32/42	Mentor Wattage Switchable LED Batten CCT, Dali Dim, 1200mm (4ft)	4100-5600	3/4/6000K	50000
10288	47/55	Mentor Wattage Switchable LED Batten CCT, Dali Dim, 1500mm (5ft)	6100-7850	3/4/6000K	50000
10281	-	Plug in Emergency Pack for above	-	-	-
10282	-	Plug in Microwave Sensor On/Off for above	-	-	-
10293	-	Plug in On/Off PIR for above	-	-	-
10294	-	Remote Control for CCT Battens (PIR only)	-	-	-
91359	-	Plug In Self Test pack for CCT Battens	-	-	-

### Microwave Max Operating Height 3.2m

Emergency versions must be tested in line with the requirements of BS5266, failure to do so may effect battery life and warranty

<sup>1</sup> Exceeds EU standard of 70 for Lumens Maintenance Ratio  
<sup>2</sup> Exceeds EU standard of RA 80 for Colour Rendering Index  
<sup>3</sup> Subject to terms & conditions (Contact Customer Service)





## LED Integrated Batten

The Ultra Batten is a versatile general-purpose luminaire. With a sleek look, this Ultra Batten is an ideal candidate for all commercial environments. Offered in 4, 5 & 6ft lengths, and boasting a 7 year warranty with a 2 year on site warranty.

- The ideal replacement for Single/Twin Fluorescent T8 and T5 Fixtures
- Special high light transmission frosted polycarbonate diffuser for smooth uniform lighting
- Perfect for all commercial environments
- Tool-free termination
- Integrated controls
- Shatterproof
- Suitable for BESA Box mounting
- 8M detection range on corridor dim option (2.6m mounting height)
- 147 Lm/W



**LMR80:** Maximum 20% of lumen depreciation over rated hours.

**B10:** Maximum 10% of fittings failure rate over rated hours

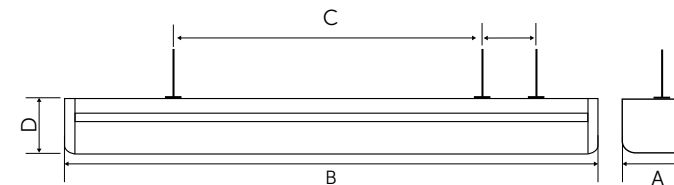

Model	A	B	C (From Centre)	D
20W	69mm	1230mm	290mm / 170mm / 320mm	82mm
40W	109mm	1230mm	290mm / 170mm / 320mm	82mm
30W	69mm	1530mm	290mm / 170mm / 320mm	82mm
60W	109mm	1530mm	290mm / 170mm / 320mm	82mm
50W	69mm	1795mm	415mm / 170mm / 320mm	82mm
80W	109mm	1795mm	415mm / 170mm / 320mm	82mm



## LED Integrated Batten

Technical Specification	
Construction	Steel Body, Polycarbonate lens
Driver	BELL
LED Chip	Samsung
IP Rating	IP20
Operating Temp	-30°C to +35°C / Emergency version minimum temperature -5°C
Input Voltage	220 - 240V
Power Factor	> 0.9
CRI	85 - Exceeds EU standard of Ra 80 for Colour Rendering Index
LMR	80 - Exceeds EU standard of 70 for Lumens Maintenance Ratio
L1A / L1B / L2A / L2B Compliant	Yes

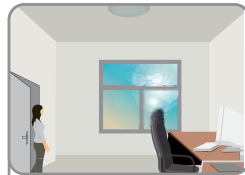

With sufficient natural light, the fitting does not switch on when presence is detected.



With insufficient natural light, the sensor switches on automatically when someone enters the room.



When the room is empty, light dims to stand-by level (10% / 20% / 30%) after the hold-time.

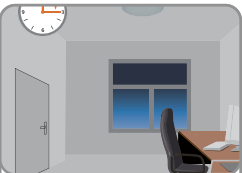

Light switched off automatically after the stand-by period has elapsed.

## Tri-Level Control (Corridor Function)



Optional infra-red remote control available for microwave sensor versions.

Quick and easy adjustment for multiple fittings; dimming level, presence detection, light levels & automatic on-off time. Average 4M range

Offers 3 levels of light: 100%-dimmed light (10%, 20%, 30%)-off; and 2 periods of selectable waiting time: motion hold-time and stand-by period; selectable daylight threshold and choice of detection area.

<sup>1</sup> Exceeds EU standard of 70 for Lumens Maintenance Ratio

<sup>2</sup> Exceeds EU standard of RA 80 for Colour Rendering Index

<sup>3</sup> Subject to terms & conditions (Contact Customer Service)

## LED Integrated Batten

Code	W	Description	Temp	Lm	Hrs
10200	20	Ultra LED Integrated - Single 1230mm (4ft)	4000K	2800	50000
10202	20	Ultra LED Integrated - Single with Microwave Sensor 1230mm (4ft)	4000K	2800	50000
10204	20	Ultra LED Integrated - Single with Microwave Sensor + Corridor Dim Function 1230mm (4ft)	4000K	2800	50000
10201	20	Ultra LED Integrated - Single Emergency 1230mm (4ft)	4000K	2800	50000
10203	20	Ultra LED Integrated - Single Emergency with Microwave Sensor 1230mm (4ft)	4000K	2800	50000
10205	20	Ultra LED Integrated - Single Emergency with Microwave Sensor + Corridor Dim Function 1230mm (4ft)	4000K	2800	50000
10206	40	Ultra LED Integrated - Double 1230mm (4ft)	4000K	5550	50000
10208	40	Ultra LED Integrated - Double with Microwave Sensor 1230mm (4ft)	4000K	5550	50000
10210	40	Ultra LED Integrated - Double with Microwave Sensor + Corridor Dim Function 1230mm (4ft)	4000K	5550	50000
10207	40	Ultra LED Integrated - Double Emergency 1230mm (4ft)	4000K	5550	50000
10209	40	Ultra LED Integrated - Double Emergency with Microwave Sensor 1230mm (4ft)	4000K	5550	50000
10211	40	Ultra LED Integrated - Double Emergency with Microwave Sensor + Corridor Dim Function 1230mm (4ft)	4000K	5550	50000
10212	30	Ultra LED Integrated - Single 1530mm (5ft)	4000K	4600	50000
10214	30	Ultra LED Integrated - Single with Microwave Sensor 1530mm (5ft)	4000K	4600	50000
10216	30	Ultra LED Integrated - Single with Microwave Sensor + Corridor Dim Function 1530mm (5ft)	4000K	4600	50000
10213	30	Ultra LED Integrated - Single Emergency 1530mm (5ft)	4000K	4600	50000
10215	30	Ultra LED Integrated - Single Emergency with Microwave Sensor 1530mm (5ft)	4000K	4600	50000
10217	30	Ultra LED Integrated - 4000K, Single Emergency with Microwave Sensor + Corridor Dim Function 1530mm (5ft)	4000K	4600	50000
10218	60	Ultra LED Integrated - Double 1530mm (5ft)	4000K	7900	50000
10220	60	Ultra LED Integrated - Double with Microwave Sensor 1530mm (5ft)	4000K	7900	50000
10222	60	Ultra LED Integrated - Double with Microwave Sensor + Corridor Dim Function 1530mm (5ft)	4000K	7900	50000
10219	60	Ultra LED Integrated - Double Emergency 1530mm (5ft)	4000K	7900	50000
10221	60	Ultra LED Integrated - Double Emergency with Microwave Sensor 1530mm (5ft)	4000K	7900	50000
10223	60	Ultra LED Integrated - Double Emergency with Microwave Sensor + Corridor Dim Function 1530mm (5ft)	4000K	7900	50000
10224	50	Ultra LED Integrated - Single 1795mm (6ft)	4000K	6500	50000
10226	50	Ultra LED Integrated - Single with Microwave Sensor 1795mm (6ft)	4000K	6500	50000

**Microwave Max Operating Height 3.2m**

Emergency versions must be tested in line with the requirements of BS5266, failure to do so may effect battery life and warranty

## LED Integrated Batten

128

Code	W	Description	Temp	Lm	Hrs
10228	50	Ultra LED Integrated - Single with Microwave Sensor + Corridor Dim Function 1795mm (6ft)	4000K	6500	50000
10225	50	Ultra LED Integrated - Single Emergency 1795mm (6ft)	4000K	6500	50000
10227	50	Ultra LED Integrated - Single Emergency with Microwave Sensor 1795mm (6ft)	4000K	6500	50000
10229	50	Ultra LED Integrated - Single Emergency with Microwave Sensor + Corridor Dim Function 1795mm (6ft)	4000K	6500	50000
10230	80	Ultra LED Integrated - Double 1795mm (6ft)	4000K	11650	50000
10232	80	Ultra LED Integrated - Double with Microwave Sensor 1795mm (6ft)	4000K	11650	50000
10234	80	Ultra LED Integrated - Double with Microwave Sensor + Corridor Dim Function 1795mm (6ft)	4000K	11650	50000
10231	80	Ultra LED Integrated - Double Emergency 1795mm (6ft)	4000K	11650	50000
10233	80	Ultra LED Integrated - Double Emergency with Microwave Sensor 1795mm (6ft)	4000K	11650	50000
10235	80	Ultra LED Integrated - Double Emergency with Microwave Sensor + Corridor Dim Function 1795mm (6ft)	4000K	11650	50000
06772	-	Remote Control for above sensor versions (corridor dim only)	-	-	-
08679	-	Batten Mount PIR	-	-	-
08673	-	Remote Control for above Batten Mount PIR on/off	-	-	-

### Microwave Max Operating Height 3.2m

Emergency versions must be tested in line with the requirements of BS5266, failure to do so may effect battery life and warranty



129

### Vauxhall Assembly Plant, Luton: BELL Ultra LED Integrated Battens

Over the life of the fittings, Vauxhall Assembly Plant could save £2,159,231 in energy & maintenance costs, energy saving 64%

- Annual Energy Saving 1,228,500kWh
- Annual CO<sub>2</sub> Saving 687,960kg
- Annual Maintenance Saving £21,000



# Ultra

## LED CCT Integrated Batten

The Ultra LED CCT is a versatile general-purpose batten. The Ultra CCT has the reliable features of the standard Ultra battens combined with the additional benefits of selectable colour temperature and wattage. Plug in emergency packs, Microwave and PIR on/off sensors create a very stock friendly solution for wholesalers and contractors alike.

- The ideal replacement for Single/Twin Fluorescent T8 and T5 Fixtures
- Special high light transmission frosted polycarbonate diffuser
- Tool-free termination
- Shatterproof
- Plug in accessories
- Stock friendly product



LMR80: Maximum 20% of lumen depreciation over rated hours.  
 B10: Maximum 10% of fittings failure rate over rated hours

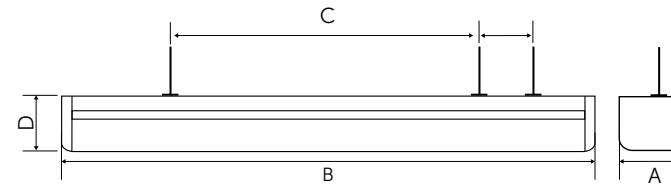

Model	A	B	C (From Centre)	D
20/40W	69mm	1230mm	290mm / 170mm / 320mm	82mm
30/60W	69mm	1530mm	290mm / 170mm / 320mm	82mm
40/80W	69mm	1795mm	415mm / 170mm / 320mm	82mm

W	Colour Temp (K) Selected	Lm
20	3000	2850
	4000	2950
	6000	2960
40	3000	5000
	4000	5400
	6000	5200
30	3000	4100
	4000	4400
	6000	4450
60	3000	7000
	4000	7700
	6000	7550
40	3000	5350
	4000	5650
	6000	5650
80	3000	9850
	4000	10850
	6000	10400





## LED CCT Integrated Batten

Code	W	Description	Lm	Temp	Hours
10278	20/40	Ultra LED Integrated Batten - CCT, 1200mm (4ft)	2850-5400	3/4/6000K	50000
10279	30/60	Ultra LED Integrated Batten - CCT, 1500mm (5ft)	4100-7700	3/4/6000K	50000
10280	40/80	Ultra LED Integrated Batten - CCT, 1800mm (6ft)	5350-10850	3/4/6000K	50000
10281	-	Plug in Emergency Pack for CCT Battens	-	-	-
10282	-	Plug in Sensor On/Off for CCT Battens	-	-	-
10293	-	Plug in PIR for CCT Battens	-	-	-
10294	-	Remote Control for CCT Battens (PIR only)	-	-	-
91359	-	Plug In Self Test pack for CCT Battens	-	-	-

### PIR Max Operating Height 3.2m

Emergency versions must be tested in line with the requirements of BS5266, failure to do so may effect battery life and warranty



## LED CCT Integrated Batten

Technical Specification	
Construction	Steel Body, Polycarbonate lens
Driver	BELL
LED Chip	Samsung
IP Rating	IP20
Operating Temp	-30°C to +35°C / Emergency version minimum temperature -5°C
Input Voltage	220 - 240V
Power Factor	> 0.9
CRI	85 - Exceeds EU standard of Ra 80 for Colour Rendering Index
LMR	80 - Exceeds EU standard of 70 for Lumens Maintenance Ratio
L1A / L1B / L2A / L2B Compliant	Yes

<sup>1</sup> Exceeds EU standard of 70 for Lumens Maintenance Ratio

<sup>2</sup> Exceeds EU standard of RA 80 for Colour Rendering Index

<sup>3</sup> Subject to terms & conditions (Contact Customer Service)



## LED Integrated Batten

The Ultra Slim LED Integrated Batten is a cost-effective shatterproof luminaire ideal for domestic applications. The Ultra Slim streamlined design gives the ability to seamlessly illuminate small spaces without the need for a large luminaire.

- The ideal replacement for Single/Twin Fluorescent T8 and T5 Fixtures
- Special high light transmission frosted polycarbonate diffuser for smooth uniform lighting
- Cool White
- Quick and easy installation
- Shatterproof
- Class 2 product, no need for earth



**LMR80:** Maximum 20% of lumen depreciation over rated hours.  
**B10:** Maximum 10% of fittings failure rate over rated hours



Model	A	B	C
38W	75mm	1230mm	26mm
45W	75mm	1530mm	26mm
56W	75mm	1850mm	26mm

# Ultralim

## LED Integrated Batten

### Technical Specification

Construction	Aluminium Body, Polycarbonate lens
Driver	BELL
LED Chip	Samsung
IP Rating	IP20
Operating Temp	-30°C to +35°C / Emergency Version -10°C to +35°C
Input Voltage	220 - 240V
Power Factor	> 0.9
CRI	85 - Exceeds EU standard of Ra 80 for Colour Rendering Index
LMR	80 - Exceeds EU standard of 70 for Lumens Maintenance Ratio
L1A / L1B / L2A / L2B Compliant	Yes

Code	W	Description	Temp	Lm	Hrs
10270	38	Ultra Slim LED Integrated - Single 1230mm (4ft)	4000K	4400	35000
10271	45	Ultra Slim LED Integrated - Single 1530mm (5ft)	4000K	5300	35000
10272	56	Ultra Slim LED Integrated - Single 1850mm (6ft)	4000K	6600	35000

<sup>1</sup> Exceeds EU standard of 70 for Lumens Maintenance Ratio  
<sup>2</sup> Exceeds EU standard of RA 80 for Colour Rendering Index  
<sup>3</sup> Subject to terms & conditions (Contact Customer Service)





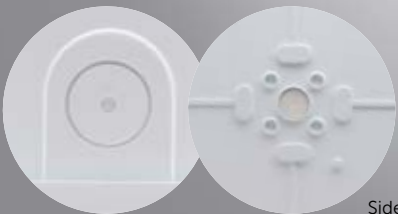

Side, Rear & BESA Box cable entry

# LED CCT Wattage Switchable Bulkhead

This cost-effective, colour switchable bulkhead is an ideal replacement for 16w, 28w and 38w fluorescent fittings. With the benefits of a high transmission frosted diffuser, rear, side & BESA Box cable entry and is IP65 as standard.

- CCT Cool White / Warm White / Daylight (3/4/6000K)
- The smart replacement for 16w, 28w and 38w fluorescent
- Tri level control now included on corridor dim versions
- Microwave and corridor dimming function option
- Supplied with White Bezel or Black Bezel
- White and Black Eyelids available
- High transmission frosted diffuser
- No lamp replacement
- No maintenance
- 50000 hour life
- IP65 Sealed fitting
- 8M detection range on corridor dim option (2.6m mounting height)
- Rear, Side & BESA Box cable entry
- Supplied with tamper-proof screws

Wattage Selected	Colour Temp (K) Selected	Lumens (lm)
9W	3000	870
	4000	930
	6000	930
14W	3000	1250
	4000	1400
	6000	1350
18W	3000	1490
	4000	1700
	6000	1620

9W Energy Saving 44%    14W Energy Saving 50%    18W Energy Saving 52%

LMR80: Maximum 20% of lumen depreciation over rated hours.  
 B10: Maximum 10% of fittings failure rate over rated hours

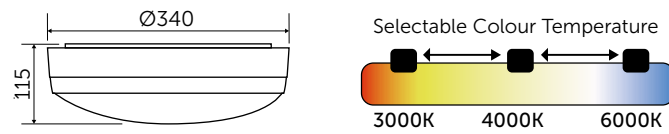

# LED CCT Wattage Switchable Bulkhead

## Technical Specification

Construction	Polycarbonate body and lens
Driver	BELL
LED Chip	Samsung
IP Rating	IP65
Operating Temp	-20°C to +40°C
Input Voltage	220 - 240V
Power Factor	> 0.9
CRI	85 - Exceeds EU standard of Ra 80 for Colour Rendering Index
LMR	80 - Exceeds EU standard of 70 for Lumens Maintenance Ratio

Code	W	Description	Lm	Temp	Hours
11600	9/14/18	AQUA1 CCT Wattage Switchable Standard White Bezel	870-1700	3/4/6000K	50000
11601	9/14/18	AQUA1 CCT Wattage Switchable Emergency White Bezel	870-1700	3/4/6000K	50000
11602	9/14/18	AQUA1 CCT Wattage Switchable M/Wave Sen on/off White Bezel	870-1700	3/4/6000K	50000
11603	9/14/18	AQUA1 CCT Wattage Switchable Emergency M/Wave Sen on/off White Bezel	870-1700	3/4/6000K	50000
11604	9/14/18	AQUA1 CCT Wattage Switchable M/Wave Sen Cor/Dim White Bezel	870-1700	3/4/6000K	50000
11605	9/14/18	AQUA1 CCT Wattage Switchable Emergency M/Wave Sen Cor/Dim White Bezel	870-1700	3/4/6000K	50000
11590	9/14/18	AQUA1 CCT Wattage Switchable Standard Black Bezel	870-1700	3/4/6000K	50000
11591	9/14/18	AQUA1 CCT Wattage Switchable Emergency Black Bezel	870-1700	3/4/6000K	50000
11592	9/14/18	AQUA1 CCT Wattage Switchable M/Wave Sen on/off Black Bezel	870-1700	3/4/6000K	50000
11593	9/14/18	AQUA1 CCT Wattage Switchable Emergency M/Wave Sen on/off Black Bezel	870-1700	3/4/6000K	50000
11594	9/14/18	AQUA1 CCT Wattage Switchable M/Wave Sen Cor/Dim Black Bezel	870-1700	3/4/6000K	50000
11595	9/14/18	AQUA1 CCT Wattage Switchable Emergency M/Wave Sen Cor/Dim Black Bezel	870-1700	3/4/6000K	50000
11256	-	Black Bezel for above	-	-	-
11257	-	White Eyelid for above	-	-	-
11258	-	Black Eyelid for above	-	-	-

Microwave Max Operating Height 3.2m

Emergency versions must be tested in line with the requirements of BS5266, failure to do so may effect battery life and warranty



With sufficient natural light, the fitting does not switch on when presence is detected.



With insufficient natural light, the sensor switches on automatically when someone enters the room.



When the room is empty, light dims to stand-by level (10% / 20% / 30%) after the hold-time.



Light switched off automatically after the stand-by period has elapsed.

### Tri-Level Control (Corridor Function)

Offers 3 levels of light: 100%-dimmed light (10%, 20%, 30%)-off; and 2 periods of selectable waiting time: motion hold-time and stand-by period; selectable daylight threshold and choice of detection area.

## Universal Wattage Switchable LED Gear Tray

Colour selectable as standard, our Universal Wattage Switchable LED Gear Tray is a versatile product which allows the user to upgrade existing bulkheads with ease. With three colour temperature and wattage options, this practical product can directly replace most existing circular bulkhead gear trays.

- Retrofit Gear Tray 16/28/32W 2D Fittings
- 3 CCT (3/4/6000K)
- 3 Wattages
- Emergency & sensor versions
- 30000 Hours
- 3 Year warranty

Code	V	W	Temp	Lumens	Description	Hours
11606	220-240	9/14/18	3/4/6000K	1200-2200	Universal Wattage Switchable LED Gear Tray - Standard, CCT	30000
11607	220-240	9/14/18	3/4/6000K	1200-2200	Universal Wattage Switchable LED Gear Tray - Emergency, CCT	30000
11608	220-240	9/14/18	3/4/6000K	1200-2200	Universal Wattage Switchable LED Gear Tray - Microwave Sensor, CCT	30000
11609	220-240	9/14/18	3/4/6000K	1200-2200	Universal Wattage Switchable LED Gear Tray - Emergency, Microwave Sensor, CCT	30000

Emergency versions must be tested in line with the requirements of BS5266, failure to do so may effect battery life and warranty



Ø 246mm  
D 50mm

<sup>3</sup> Subject to terms & conditions (Contact Customer Service)







Index

## LED CCT Bulkhead

The Deco Slim LED Bulkhead is one of the most decorative, aesthetically pleasing bulkheads in the BELL range. Supplied with white bezel as standard with the option to add a variety of decorative bezels.

- Selectable colour temperature version 3000K/4000K/6000K available
- Supplied with white trim, chrome, satin, copper and antique brass trims available
- The ideal replacement for 2D and PL decorative fittings
- 8M detection range on corridor dim option (2.6m mounting height)
- Emergency option
- Microwave and corridor dimming function option (non CCT version)
- Rear entry

12W  $\frac{28}{W}$  Energy Saving 57%    18W  $\frac{38}{W}$  Energy Saving 52%    25W  $\frac{55}{W}$  Energy Saving 54%



LMR80: Maximum 20% of lumen depreciation over rated hours.  
 B10: Maximum 10% of fittings failure rate over rated hours

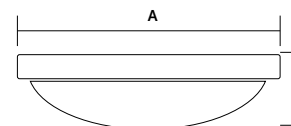

Model	A Ø	B Depth
12W	250mm	48mm
18W	300mm	48mm
25W	300mm	48mm

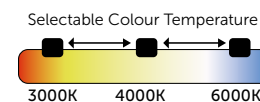

## LED CCT Bulkhead

Technical Specification	
Construction	Polycarbonate
Driver	BELL
LED Chip	Samsung
IP Rating	IP54
Operating Temp	-20°C to +35°C / Emergency version minimum temperature -5°C
Input Voltage	220 - 240V
Power Factor	> 0.9
CRI	85 - Exceeds EU standard of Ra 80 for Colour Rendering Index
LMR	80 - Exceeds EU standard of 70 for Lumens Maintenance Ratio
L1A / L1B / L2A / L2B Compliant	Yes

## Tri-Level Control (Corridor Function)



With sufficient natural light, the fitting does not switch on when presence is detected.

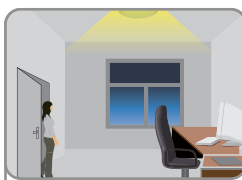

With insufficient natural light, the sensor switches on automatically when someone enters the room.



When the room is empty, light dims to stand-by level (10% / 20% / 30%) after the hold-time.



Light switched off automatically after the stand-by period has elapsed.

Optional infra-red remote control available for sensor versions

Quick and easy adjustment for multiple fittings; dimming level, presence detection, light levels & automatic on-off time. Average 4M range.

Offers 3 levels of light: 100%-dimmed light (10%, 20%, 30%)-off; and 2 periods of selectable waiting time: motion hold-time and stand-by period; selectable daylight threshold and choice of detection area.

<sup>1</sup> Exceeds EU standard of 70 for Lumens Maintenance Ratio  
<sup>2</sup> Exceeds EU standard of RA 80 for Colour Rendering Index  
<sup>3</sup> Subject to terms & conditions (Contact Customer Service)

Code	W	Description	Lm	Lm/w	Temp	Hours
06830	12	Deco Slim LED Bulkhead CCT	1056	88	3/4/6000K	50000
06831	18	Deco Slim LED Bulkhead CCT	1620	90	3/4/6000K	50000
06832	25	Deco Slim LED Bulkhead CCT	2150	86	3/4/6000K	50000
06833	12	Deco Slim LED Bulkhead CCT Emergency	1056	88	3/4/6000K	50000
06834	18	Deco Slim LED Bulkhead CCT Emergency	1620	90	3/4/6000K	50000
06835	25	Deco Slim LED Bulkhead CCT Emergency	2150	86	3/4/6000K	50000
06824	12	Deco Slim LED Bulkhead CCT Sensor On/Off	1056	88	3/4/6000K	50000
06825	18	Deco Slim LED Bulkhead CCT Sensor On/Off	1620	90	3/4/6000K	50000
06826	25	Deco Slim LED Bulkhead CCT Sensor On/Off	2150	86	3/4/6000K	50000
06827	12	Deco Slim LED Bulkhead CCT Sensor Emergency	1056	88	3/4/6000K	50000
06828	18	Deco Slim LED Bulkhead CCT Sensor Emergency	1620	90	3/4/6000K	50000
06829	25	Deco Slim LED Bulkhead CCT Sensor Emergency	2150	86	3/4/6000K	50000
06752	-	Satin Trim for 12W Deco Slim LED Bulkhead	-	-	-	-
06753	-	Satin Trim for 18/25W Deco Slim LED Bulkhead	-	-	-	-
06754	-	Chrome Trim for 12W Deco Slim LED Bulkhead	-	-	-	-
06755	-	Chrome Trim for 18/25W Deco Slim LED Bulkhead	-	-	-	-
06756	-	Copper Trim for 12W Deco Slim LED Bulkhead	-	-	-	-
06757	-	Copper Trim for 18/25W Deco Slim LED Bulkhead	-	-	-	-
06758	-	Antique Brass Trim for 12W Deco Slim LED Bulkhead	-	-	-	-
06759	-	Antique Brass Trim for 18/25W Deco Slim LED Bulkhead	-	-	-	-

Contact Customer Service for Emergency, Microwave and Corridor Dimming options

**Microwave Max Operating Height 3.2m**

Emergency versions must be tested in line with the requirements of BS5266, failure to do so may effect battery life and warranty



#### Rotherham College: BELL Deco Slim LED Bulkheads

Over the life of the fittings, Rotherham College could save: £5376 in energy costs, energy saving 34%

- Annual Energy Saving 2,796kWh
- Annual CO<sub>2</sub> Saving 1,565kg
- Annual Maintenance £600





## LED Bulkhead

Colour selectable as standard, the Deco Grande is a unique bulkhead that combines a large surface area of light with a decorative feel. Supplied with a white bezel as standard with additional coloured bezels available on request.

- Selectable colour temperature 3000K/4000K/6000K
- Supplied with white trim, chrome, satin nickel, copper and antique brass trims available
- Colour change switch under diffuser for easy access
- The ideal replacement for 2D and PL decorative fittings
- 8M detection range on corridor dim option (2.6m mounting height)
- Emergency option
- Microwave and corridor dimming function option
- 20mm side & rear entry conduit

25W 55W 54%



LMR80: Maximum 20% of lumen depreciation over rated hours.  
 B10: Maximum 10% of fittings failure rate over rated hours

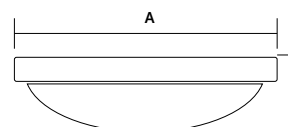

Model	A Ø	B Depth
25W	390mm	94mm

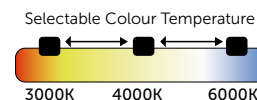

## LED Bulkhead

Technical Specification	
Construction	Polycarbonate
Driver	BELL
LED Chip	Samsung
IP Rating	IP54
Operating Temp	-20°C to +35°C
Input Voltage	220 - 240V
Power Factor	> 0.9
CRI	85 - Exceeds EU standard of Ra 80 for Colour Rendering Index
LMR	80 - Exceeds EU standard of 70 for Lumens Maintenance Ratio
L1A / L1B / L2A / L2B Compliant	Yes

Code	V	W	Temp	Lm	Description	Hours
06810	240	25	3000/4000/6000K	2000	Deco Grande CCT Colour Change LED Bulkhead	35000
06811	240	25	3000/4000/6000K	2000	Deco Grande CCT Colour Change LED Bulkhead - Emergency	35000
06812	240	25	3000/4000/6000K	2000	Deco Grande CCT Colour Change LED Bulkhead - Corridor Dim	35000
06813	240	25	3000/4000/6000K	2000	Deco Grande CCT Colour Change LED Bulkhead - Emergency, Corridor Dim	35000
06816	-	-	-	-	Satin Nickel Trim Ring for 25W Deco Grande CCT Colour Change LED Bulkhead	-
06817	-	-	-	-	Chrome Trim Ring for 25W Deco Grande CCT Colour Change LED Bulkhead	-
06818	-	-	-	-	Copper Trim Ring for 25W Deco Grande CCT Colour Change LED Bulkhead	-
06819	-	-	-	-	Antique Brass Trim Ring for 25W Deco Grande CCT Colour Change LED Bulkhead	-

### Microwave Max Operating Height 3.2m

Emergency versions must be tested in line with the requirements of BS5266, failure to do so may effect battery life and warranty

<sup>1</sup> Exceeds EU standard of 70 for Lumens Maintenance Ratio  
<sup>2</sup> Exceeds EU standard of RA 80 for Colour Rendering Index  
<sup>3</sup> Subject to terms & conditions (Contact Customer Service)

### Tri-Level Control (Corridor Function)

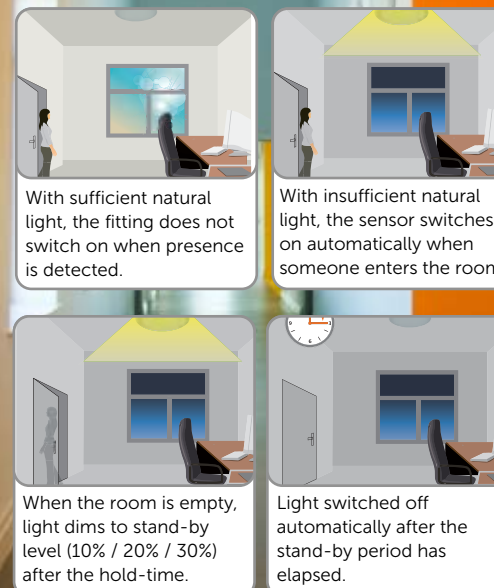

With sufficient natural light, the fitting does not switch on when presence is detected.

With insufficient natural light, the sensor switches on automatically when someone enters the room.

When the room is empty, light dims to stand-by level (10% / 20% / 30%) after the hold-time.

Light switched off automatically after the stand-by period has elapsed.

Offers 3 levels of light: 100%-dimmed light (10%, 20%, 30%)-off; and 2 periods of selectable waiting time: motion hold-time and stand-by period; selectable daylight threshold and choice of detection area.

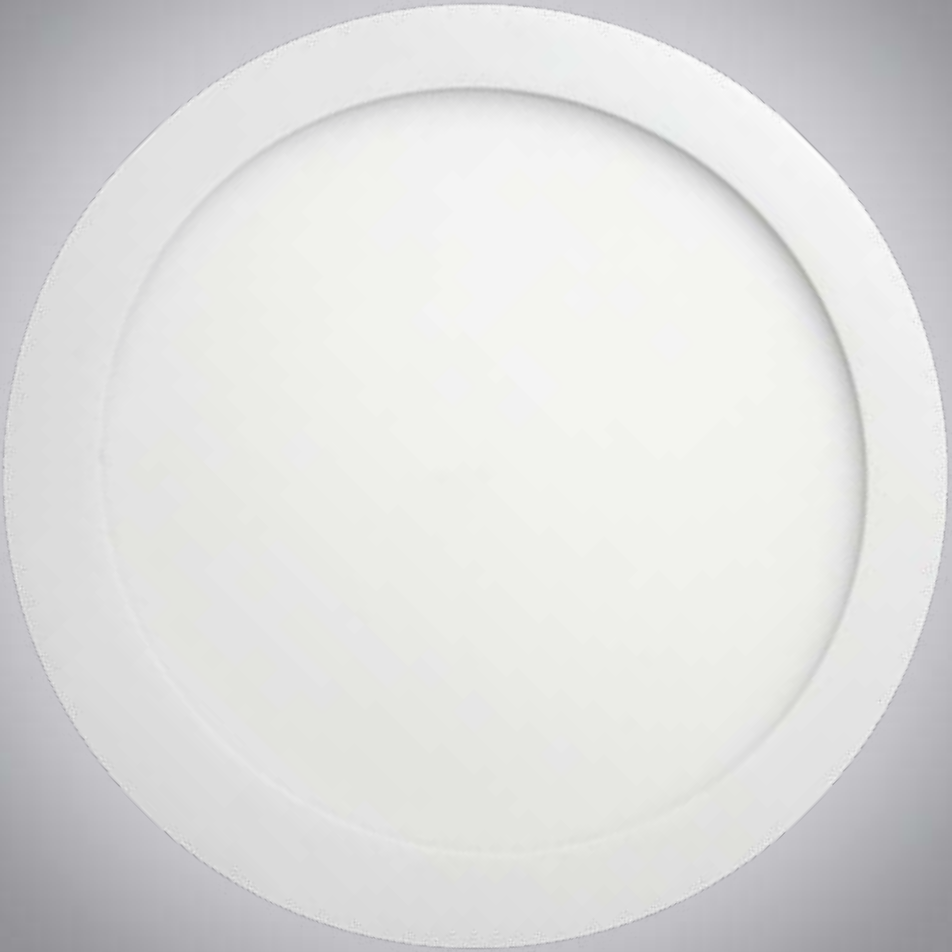

# LED Round Panel

The super slim design of the BELL Ariall LED Round Panel makes this range of products ideal for office & educational environments alike. The complete range covers cut outs ranging from 130mm up to 282mm.

- Super slimline profile
- Remote Micro Driver
- Complete range covering sizes 146mm - 300mm
- Flicker Free Driver to ensure safety in public areas
- 30000 Hours
- 0-10V dimming or DALI dimming options available
- Emergency panels with 5 year battery warranty available



LMR80: Maximum 20% of lumen depreciation over rated hours.  
 B10: Maximum 10% of fittings failure rate over rated hours

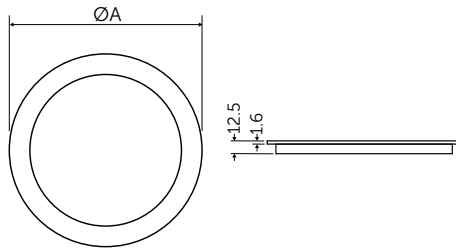

Model	A	Cut-Out
9W	146mm	130mm
12W	170mm	160mm
15W	190mm	180mm
18W	225mm	210mm
24W	300mm	282mm





## LED Round Panel

Technical Specification	
Construction	Aluminium + PMMA
Driver	BELL
LED Chip	Philips
IP Rating	IP44
Operating Temp	0°C to +35°C
Input Voltage	220 - 240V
Power Factor	> 0.9
CRI	85 - Exceeds EU standard of Ra 80 for Colour Rendering Index
LMR	80 - Exceeds EU standard of 70 for Lumens Maintenance Ratio
L1A / L1B / L2A / L2B Compliant	Yes
Emergency Battery Type	NiCd 1 Year Emergency

Code	W	Description	Lm	Temp	Hours
09730	9	Ø 146mm Arial Round LED Panel	630	4000K	30000
09729	12	Ø 170mm Arial Round LED Panel	1130	4000K	30000
09731	15	Ø 190mm Arial Round LED Panel	1520	4000K	30000
09732	18	Ø 225mm Arial Round LED Panel	1800	4000K	30000
09733	24	Ø 300mm Arial Round LED Panel	2430	4000K	30000
09695	9	Ø 146mm Arial Round LED Panel - Emergency	630	4000K	30000
09696	12	Ø 170mm Arial Round LED Panel - Emergency	1130	4000K	30000
09697	15	Ø 190mm Arial Round LED Panel - Emergency	1520	4000K	30000
09698	18	Ø 225mm Arial Round LED Panel - Emergency	1800	4000K	30000
09699	24	Ø 300mm Arial Round LED Panel - Emergency	2430	4000K	30000
09744	9	Ø 146mm Arial Round LED Panel - 0-10v Dim	630	4000K	30000
09745	12	Ø 170mm Arial Round LED Panel - 0-10v Dim	1130	4000K	30000
09746	15	Ø 190mm Arial Round LED Panel - 0-10v Dim	1520	4000K	30000
09747	18	Ø 225mm Arial Round LED Panel - 0-10v Dim	1800	4000K	30000
09748	24	Ø 300mm Arial Round LED Panel - 0-10v Dim	2430	4000K	30000
09739	9	Ø 146mm Arial Round LED Panel - Dali Dim	630	4000K	30000
09740	12	Ø 170mm Arial Round LED Panel - Dali Dim	1130	4000K	30000
09741	15	Ø 190mm Arial Round LED Panel - Dali Dim	1520	4000K	30000



Code	W	Description	Lm	Temp	Hours
09742	18	Ø 225mm Arial Round LED Panel - Dali Dim	1800	4000K	30000
09743	24	Ø 300mm Arial Round LED Panel - Dali Dim	2430	4000K	30000
08747	-	LED Self Test or Manual Emergency Pack	-	-	-

Available on request:

- Emergency panels with 5 year battery warranty
- Emergency 0-10V Dim
- Emergency Dali Dim

For further information call 01924 893380 or email [sales@belllighting.co.uk](mailto:sales@belllighting.co.uk)

Emergency versions must be tested in line with the requirements of BS5266, failure to do so may effect battery life and warranty.

<sup>1</sup> Exceeds EU standard of 70 for Lumens Maintenance Ratio  
<sup>2</sup> Exceeds EU standard of RA 80 for Colour Rendering Index  
<sup>3</sup> Subject to terms & conditions (Contact Customer Service)



Index



## LED Converter / Large Converter

The Arial LED Converter / Large Converter is an unrivalled product when it comes to versatility in the LED market.

- All in one solution
- Selectable colour temperature
- Integral switches for multiple wattages and CCT
- Cool White / Warm White / Daylight
- Selectable wattage
- Fully adjustable / Innovative bracket
- Converter fits cut-outs 65mm to 205mm - Large converter fits cut-outs 120mm to 260mm
- 50000 Hours
- Emergency pack available



LMR80: Maximum 20% of lumen depreciation over rated hours.  
 B10: Maximum 10% of fittings failure rate over rated hours

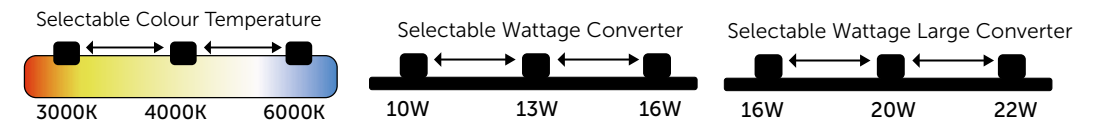
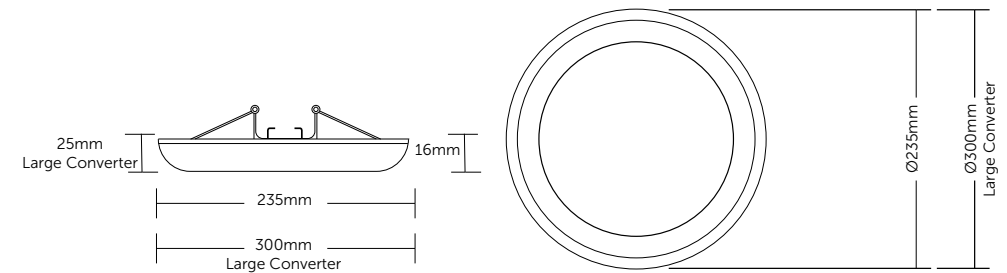





## LED Converter / Large Converter

### Technical Specification

Construction	Polycarbonate
Driver	BELL
LED Chip	Samsung
IP Rating	IP40
Operating Temp	0°C to +35°C
Input Voltage	220 - 240V
Power Factor	> 0.9
CRI	85 - Exceeds EU standard of Ra 80 for Colour Rendering Index
LMR	80 - Exceeds EU standard of 70 for Lumens Maintenance Ratio
L1A / L1B / L2A / L2B Compliant	Yes

Code	W	Description	Lm	Temp	Hours
06840	10/13/16	10/13/16W Ariel LED Converter Wattage Switchable, CCT	1070-1815	3000K/4000K/6000K	50000
06839	16/20/22	16/20/22W Ariel LED Converter Wattage Switchable, CCT	1070-1815	3000K/4000K/6000K	50000
09124	2.5	Emergency Pack for Ariel LED Converter Self Test Switchable (06840 Only)	-	-	-

Emergency versions must be tested in line with the requirements of BS5266, failure to do so may effect battery life and warranty.

Index

Colour Temp 3000K - 6000K	
10W	1070 - 1175 Lumens
13W	1325 - 1490 Lumens
16W	1590-1815 Lumens
16W	1670-1875 Lumens
20W	1985-2270 Lumens
22W	2200-2550 Lumens

<sup>1</sup> Exceeds EU standard of 70 for Lumens Maintenance Ratio  
<sup>2</sup> Exceeds EU standard of RA 80 for Colour Rendering Index  
<sup>3</sup> Subject to terms & conditions (Contact Customer Service)

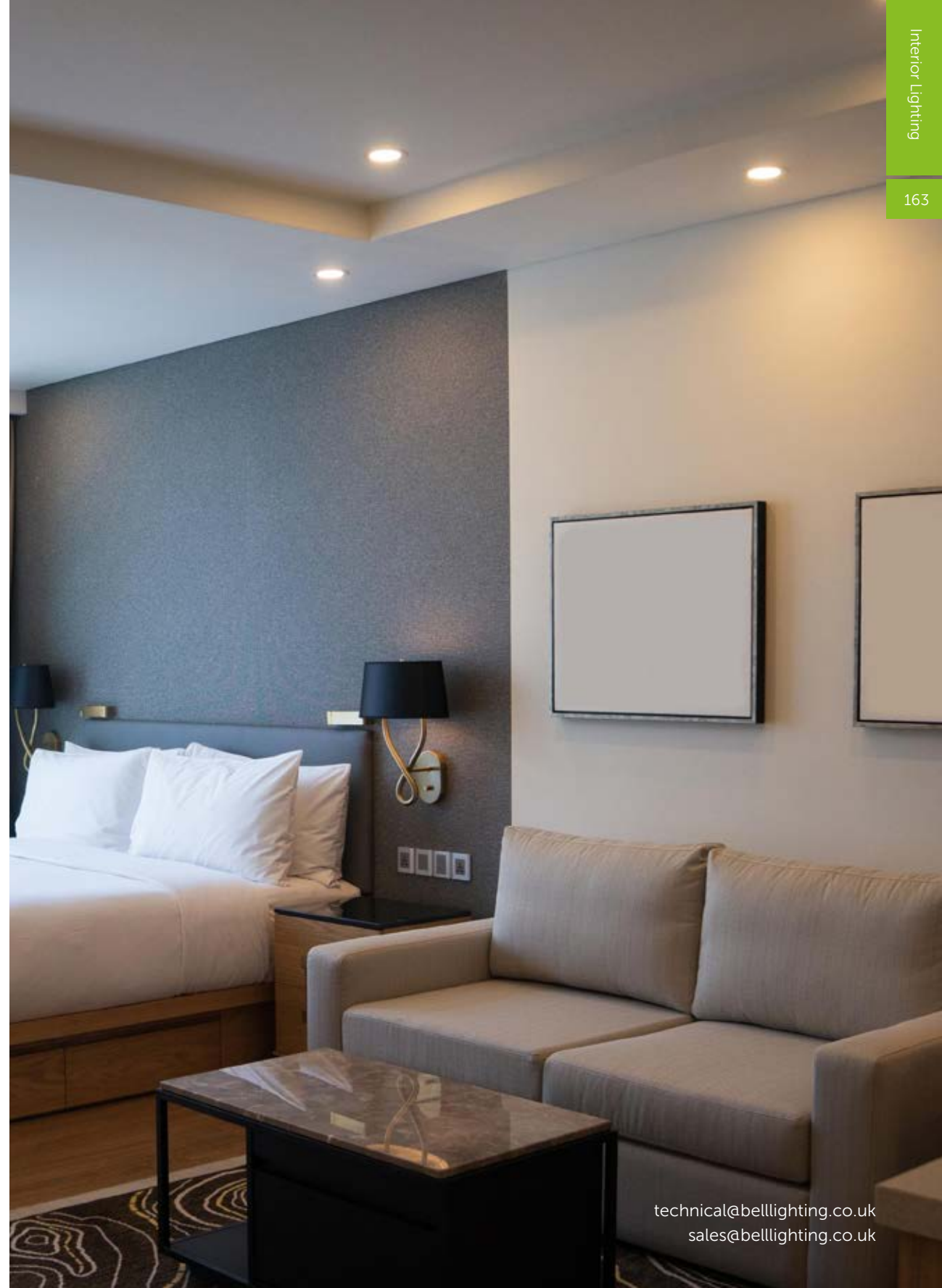



## LED CCT Downlight

The Ariel Pro LED Downlight is a sleek looking luminaire designed to replace cumbersome CFL fittings. With a 7 year warranty across both the IP44 & IP65 range, the Ariel Pro can be installed in a variety of applications with the confidence of knowing this product will stand the test of time.

- Switchable colour temperature 3000/4000/6000K
- Ideal for home and office environments
- Equivalent up to 2x26W fluorescent
- Anti-glare
- IP44 and IP65 options available
- Tool Free - Plug & Play
- Emergency downlights with 5 year battery warranty available



LMR80: Maximum 20% of lumen depreciation over rated hours.  
 B10: Maximum 10% of fittings failure rate over rated hours

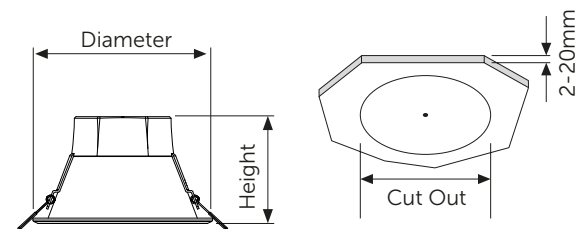

	10W	16W	20W
Diameter	115mm	190mm	240mm
Height	70.5mm	102mm	117mm
Cut Out	90mm	160mm	200mm



## LED Downlight

Code	W	Description	Lm	Temp	Hours
10953	10	10W Ariapro CCT Downlight IP65	910	3/4/6000K	50000
10954	16	16W Ariapro CCT Downlight IP65	1660	3/4/6000K	50000
10955	20	20W Ariapro CCT Downlight IP65	2250	3/4/6000K	50000
10965	10	10W Ariapro CCT Downlight IP65 - Emergency, (1 Year Battery Warranty)	910	3/4/6000K	50000
10966	16	16W Ariapro CCT Downlight IP65 - Emergency, (1 Year Battery Warranty)	1660	3/4/6000K	50000
10967	20	20W Ariapro CCT Downlight IP65 - Emergency, (1 Year Battery Warranty)	2250	3/4/6000K	50000
10968	10	10W Ariapro CCT Downlight IP65 - 1-10V Dim	910	3/4/6000K	50000
10969	16	16W Ariapro CCT Downlight IP65 - 1-10V Dim	1660	3/4/6000K	50000
10970	20	20W Ariapro CCT Downlight IP65 - 1-10V Dim	2250	3/4/6000K	50000
10971	10	10W Ariapro CCT Downlight IP65 - Dali Dim	910	3/4/6000K	50000
10972	16	16W Ariapro CCT Downlight IP65 - Dali Dim	1660	3/4/6000K	50000
10973	20	20W Ariapro CCT Downlight IP65 - Dali Dim	2250	3/4/6000K	50000
08747	-	LED Self Test or Manual Emergency Pack	-	-	-

Available on request:

- Emergency panels with 5 year battery warranty
- Emergency 0-10V Dim
- Emergency Dali Dim

For further information call 01924 893380 or email [sales@bellighting.co.uk](mailto:sales@bellighting.co.uk)

Emergency versions must be tested in line with the requirements of BS5266, failure to do so may effect battery life and warranty.



## LED Downlight

Technical Specification	
Construction	Polycarbonate
Driver	Tridonic
LED Chip	Philips
IP Rating	IP65 & IP44
Operating Temp	-5°C to +35°C
Input Voltage	220 - 240V
Power Factor	> 0.9
CRI	85 - Exceeds EU standard of Ra 80 for Colour Rendering Index
LMR	80 - Exceeds EU standard of 70 for Lumens Maintenance Ratio
L1A / L1B / L2A / L2B Compliant	Yes
Emergency Battery Type	NiCd

Code	W	Description	Lm	Temp	Hours
10950	10	10W Ariapro CCT Downlight IP44	910	3/4/6000K	50000
10951	16	16W Ariapro CCT Downlight IP44	1660	3/4/6000K	50000
10952	20	20W Ariapro CCT Downlight IP44	2250	3/4/6000K	50000
10956	10	10W Ariapro CCT Downlight IP44 - Emergency, (1 Year Battery Warranty)	910	3/4/6000K	50000
10957	16	16W Ariapro CCT Downlight IP44 - Emergency, (1 Year Battery Warranty)	1660	3/4/6000K	50000
10958	20	20W Ariapro CCT Downlight IP44 - Emergency, (1 Year Battery Warranty)	2250	3/4/6000K	50000
10959	10	10W Ariapro CCT Downlight IP44 - 1-10V Dim	910	3/4/6000K	50000
10960	16	16W Ariapro CCT Downlight IP44 - 1-10V Dim	1660	3/4/6000K	50000
10961	20	20W Ariapro CCT Downlight IP44 - 1-10V Dim	2250	3/4/6000K	50000
10962	10	10W Ariapro CCT Downlight IP44 - Dali Dim	910	3/4/6000K	50000
10963	16	16W Ariapro CCT Downlight IP44 - Dali Dim	1660	3/4/6000K	50000
10964	20	20W Ariapro CCT Downlight IP44 - Dali Dim	2250	3/4/6000K	50000

<sup>1</sup> Exceeds EU standard of 70 for Lumens Maintenance Ratio  
<sup>2</sup> Exceeds EU standard of RA 80 for Colour Rendering Index  
<sup>3</sup> Subject to terms & conditions (Contact Customer Service)



# ArialPlus multi

## Backlit High Output UGR<19 LED Panel

The Arial Plus Multi is our leading wattage switchable panel. With a high lumen output of up to 125 lumens per watt, this panel is ideal for areas that require high lux levels. The Arial Plus Multi can be installed in areas where TPa rated lighting products are essential, such as emergency exit routes including stairways and corridors.

- High efficiency
- TPa
- Uniform light distribution
- Professional LED Panel
- 0-10V Dimming or DALI Dimming options available
- White finish
- Anti-twist frame
- Emergency panels with 5 year battery warranty available
- CCT option available

Also available in bulk packs for large project orders, reducing your cost & our carbon footprints.



LMR80: Maximum 20% of lumen depreciation over rated hours.  
B10: Maximum 10% of fittings failure rate over rated hours

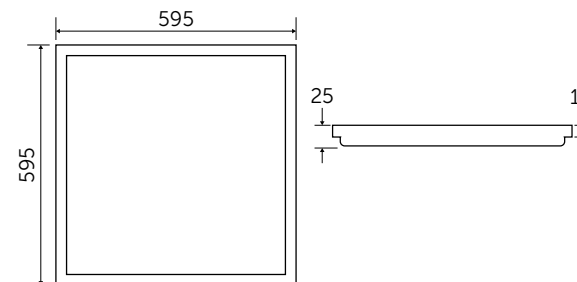

UGR (Unified Glare Rating) is a method of calculating glare from light sources.

The UGR rating helps to determine how likely a light source is to cause discomfort to those around it. This classification ranges from 5 to 40, with low numbers indicating low glare.

Glare can be a common problem in workplaces. Inappropriate lighting or excessive brightness can be bounced off reflective surfaces, such as computer screens, whiteboards etc. This can cause disruption for the occupants of offices.



**CASAMBI**  
Options Available

## Backlit High Output UGR<19 LED Panel

Technical Specification	
Construction	Steel + Polycarbonate
Driver	BELL
LED Chip	Philips
IP Rating	IP40
Operating Temp	0°C to +35°C
Input Voltage	220 - 240V
Power Factor	> 0.9
CRI	85 - Exceeds EU standard of Ra 80 for Colour Rendering Index
LMR	80 - Exceeds EU standard of 70 for Lumens Maintenance Ratio
L1A / L1B / L2A / L2B Compliant	Yes
Emergency Battery Type	NiCd 1 Year Emergency / LiFePO4 5 Year Emergency

Code	W	Description	Up to Lm/W	Lm	Temp	Hours
11748	20/26/30/36	Arial Plus Multi Backlit LED Panel - 25mm 600x600mm, 4000K, UGR<19, White	120	2400/3200 3600/4100	4000K	50000
11750	20/26/30/36	Arial Plus Multi Backlit LED Panel - 25mm 600x600mm, 4000K, UGR<19, Emergency, White (1Y Guarantee)	120	2400/3200 3600/4100	4000K	50000
11749	20/26/30/36	Arial Plus Multi Backlit LED Panel - 25mm 600x600mm, 4000K, UGR<19, Emergency, White (5Y Guarantee)	120	2400/3200 3600/4100	4000K	50000
11752	36	Arial Plus Multi Backlit LED Panel - 25mm 600x600mm, 4000K, UGR<19, White, 0-10V Dim	120	4100	4000K	50000
11751	36	Arial Plus Multi Backlit LED Panel - 25mm 600x600mm, 4000K, UGR<19, White, Dali Dim	120	4100	4000K	50000
11798	36	Arial Plus Multi Backlit LED Panel - 25mm 600x600mm, 4000K, UGR<19, White, Casambi Enabled	120	4100	4000K	50000

<sup>1</sup> Exceeds EU standard of 70 for Lumens Maintenance Ratio  
<sup>2</sup> Exceeds EU standard of RA 80 for Colour Rendering Index  
<sup>3</sup> Subject to terms & conditions (Contact Customer Service)

## Backlit High Output UGR<19 LED Panel

Code	W	Description	Up to Lm/W	Lm	Temp	Hours
11799	36	Arial Plus Multi Backlit LED Panel - 25mm 600x600mm, 4000K, UGR<19, White, Emergency (1 Year Battery Guarantee), Casambi Enabled	120	4100	4000K	50000
11764	20/26/30/36	Arial Plus Multi Backlit CCT LED Panel - 25mm 600x600mm, UGR<19, White	120*	2400/3200 3600/4100	3/4/6K	50000
11766	20/26/30/36	Arial Plus Multi Backlit CCT LED Panel - 25mm 600x600mm, UGR<19, Emergency, White (1Y Guarantee)	120*	2400/3200 3600/4100	3/4/6K	50000
11765	20/26/30/36	Arial Plus Multi Backlit CCT LED Panel - 25mm 600x600mm, UGR<19, Emergency, White (5Y Guarantee)	120*	2400/3200 3600/4100	3/4/6K	50000
11768	36	Arial Plus Multi Backlit CCT LED Panel - 25mm 600x600mm, UGR<19, White, 0-10V Dim	120*	4100	3/4/6K	50000
11767	36	Arial Plus Multi Backlit CCT LED Panel - 25mm 600x600mm, UGR<19, White, Dali Dim	120*	4100	3/4/6K	50000
11772	20/26/30/36	Arial Plus Multi Backlit LED Panel - 25mm 1200x300mm, 4000K, UGR<19, White	125	2500/3150 3550/4250	4000K	50000
11773	20/26/30/36	Arial Plus Multi Backlit LED Panel - 25mm 1200x300mm, 4000K, UGR<19, White, Emergency (1Y Guarantee)	125	2500/3150 3550/4250	4000K	50000
11776	36	Arial Plus Multi Backlit LED Panel - 25mm 1200x300mm, 4000K, UGR<19, White, 0-10V Dim	125	4250	4000K	50000

\*Lumens based on 4000K  
 Emergency versions must be tested in line with the requirements of BS5266, failure to do so may effect battery life and warranty.

## Backlit High Output UGR<19 LED Panel

Code	W	Description	Up to Lm/W	Lm	Temp	Hours
11775	36	Arial Plus Multi Backlit LED Panel - 25mm 1200x300mm, 4000K, UGR<19, White, Dali Dim	125	4250	4000K	50000
11777	36	Arial Plus Multi Backlit LED Panel - 25mm 1200x300mm, 4000K, UGR<19, White, Emergency Dali (1Y Guarantee)	125	4250	4000K	50000
11778	36	Arial Plus Multi Backlit LED Panel - 25mm 1200x300mm, 4000K, UGR<19, White, Emergency 1-10V (1Y Guarantee)	125	4250	4000K	50000
11790	30/40/50/55/60	Arial Plus Multi Backlit LED Panel - 25mm 1200x600mm, 4000K, UGR<19, White	120	3600/4650 5750/6300/6750	4000K	50000
11791	30/40/50/55/60	Arial Plus Multi Backlit LED Panel - 25mm 1200x600mm, 4000K, UGR<19, White, Emergency	120	3600/4650 5750/6300/6750	4000K	50000
11793	60	Arial Plus Multi Backlit LED Panel - 25mm 1200x600mm, 4000K, UGR<19, White, 1-10V Dim	120	6750	4000K	50000
11792	60	Arial Plus Multi Backlit LED Panel - 25mm 1200x600mm, 4000K, UGR<19, White, Dali Dim	120	6750	4000K	50000
11794	60	Arial Plus Multi Backlit LED Panel - 25mm 1200x600mm, 4000K, UGR<19, White, Emergency Dali (1Y Guarantee)	120	6750	4000K	50000
11795	60	Arial Plus Multi Backlit LED Panel - 25mm 1200x600mm, 4000K, UGR<19, White, Emergency 1-10V (1Y Guarantee)	120	6750	4000K	50000

<sup>1</sup> Exceeds EU standard of 70 for Lumens Maintenance Ratio  
<sup>2</sup> Exceeds EU standard of RA 80 for Colour Rendering Index  
<sup>3</sup> Subject to terms & conditions (Contact Customer Service)

## Backlit High Output UGR<19 LED Panel

Code	W	Description	Up to Lm/W	Lm	Temp	Hours
10190	-	Surface Mount Unit for 600x600 Arial Backlit Panel	-	-	-	-
10192	-	Surface Mount Unit for 1200x300 Arial Backlit Panel	-	-	-	-
10193	-	Surface Mount Unit for 1200x600 Arial Backlit Panel	-	-	-	-
10118	-	Suspension Kit for 600x600/1200x300 Arial Backlit Panel	-	-	-	-
08747	2.5	LED Emergency Pack (self + manual test)	-	-	-	-
30023	-	Arial Plus Multi Backlit High Output UGR<19 LED Panel. Bulk Pack (6) Requires 12016/7				
12106	20/26/30/36W	Driver for 30023				
12107	36W	Driver for 30023				

Available on request:

- Emergency panels with 5 year battery warranty
- Emergency 0-10V Dim
- Emergency Dali Dim

For further information call 01924 893380 or email [sales@bellighting.co.uk](mailto:sales@bellighting.co.uk)

Emergency versions must be tested in line with the requirements of BS5266, failure to do so may effect battery life and warranty.





**CASAMBI**  
Options Available

# Arialmulti

## Backlit LED Panel

One of the newest panels in the Arial Multi range, comes with a 7 year warranty and 2 year on site warranty as standard. This cost-effective lighting solution is available with a multitude of optional extras.

- Uniform light distribution
- Professional LED Panel
- TPb
- 0-10V Dimming or DALI Dimming options available
- Casambi Enabled Option Available
- Anti-twist frame
- Emergency panels with 5 year battery warranty available
- CCT option available on request

Also available in bulk packs for large project orders, reducing your cost & our carbon footprints



LMR80: Maximum 20% of lumen depreciation over rated hours.  
B10: Maximum 10% of fittings failure rate over rated hours

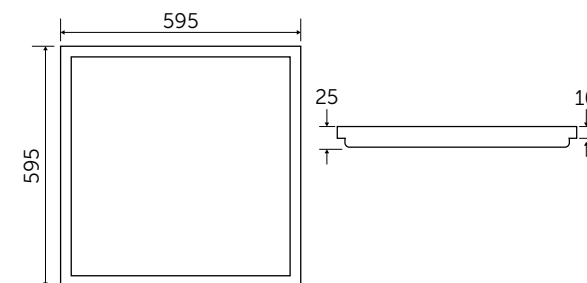

Seamless Trim Design

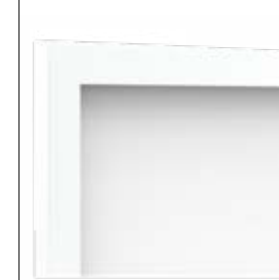

No Light Fall Off

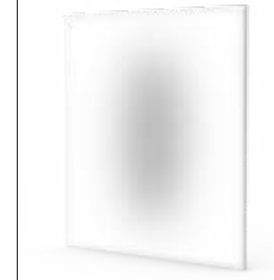

## Backlit LED Panel

Technical Specification	
Construction	Steel + PMMA
Driver	BELL
LED Chip	Philips
IP Rating	IP40
Operating Temp	0°C to +35°C
Input Voltage	220 - 240V
Power Factor	> 0.9
CRI	85 - Exceeds EU standard of Ra 80 for Colour Rendering Index
LMR	80 - Exceeds EU standard of 70 for Lumens Maintenance Ratio
L1A / L1B / L2A / L2B Compliant	Yes
Emergency Battery Type	NiCd 1 Year Emergency / LiFePO4 5 Year Emergency

Code	W	Description	Lm/W	Lm	Temp	Hours
11740	20/26/30/36	Arial Multi Backlit LED Panel - 25mm 600x600 4000K, White	115	2300/2900 3250/3770	4000K	50000
11742	20/26/30/36	Arial Multi Backlit LED Panel - 25mm 600x600mm, 4000K, Emergency, White (1Y Guarantee)	115	2300/2900 3250/3770	4000K	50000
11741	20/26/30/36	Arial Multi Backlit LED Panel - 25mm 600x600mm, 4000K, Emergency, White (5Y Guarantee)	115	2300/2900 3250/3770	4000K	50000
11744	36	Arial Multi Backlit LED Panel - 25mm 600x600mm, 4000K, White, 0-10V Dim	115	3770	4000K	50000
11743	36	Arial Multi Backlit LED Panel - 25mm 600x600mm, 4000K, White, Dali Dim	115	3770	4000K	50000
11789	36	Arial Multi Backlit LED Panel - 25mm 600x600mm, 4000K, White, Casambi Enabled	115	3770	4000K	50000
11797	36	Arial Multi Backlit LED Panel - 25mm 600x600mm, 4000K, White, Emergency (1 Year Battery Guarantee), Casambi Enabled	115	3770	4000K	50000

<sup>1</sup> Exceeds EU standard of 70 for Lumens Maintenance Ratio  
<sup>2</sup> Exceeds EU standard of RA 80 for Colour Rendering Index  
<sup>3</sup> Subject to terms & conditions (Contact Customer Service)

## Backlit LED Panel

Code	W	Description	Lm/W	Lm	Temp	Hours
11756	20/26/30/36	Arial Multi Backlit CCT LED Panel - 25mm 600x600mm, White	120*	2550/3400 2800/4450	3/4/6K	50000
11758	20/26/30/36	Arial Multi Backlit CCT LED Panel - 25mm 600x600mm, Emergency, White (1Y Guarantee)	120*	2550/3400 2800/4450	3/4/6K	50000
11757	20/26/30/36	Arial Multi Backlit CCT LED Panel 25mm 600x600mm, White, Erme (5Y Guarantee)	120*	2550/3400 2800/4450	3/4/6K	50000
11760	36	Arial Multi Backlit CCT LED Panel - 25mm 600x600mm, White, 0-10V Dim	120*	4450	3/4/6K	50000
11759	36	Arial Multi Backlit CCT LED Panel - 25mm 600x600mm, White, Dali Dim	120*	4450	3/4/6K	50000
11787	36	Arial Multi Backlit CCT LED Panel 25mm 600x600mm, White, Casambi Enabled	120*	4450	3/4/6K	50000
11788	36	Arial Multi Backlit CCT LED Panel - 25mm 600x600mm, White, Emergency (1 Year Battery Guarantee), Casambi Enabled	120*	4450	3/4/6K	50000
10190	-	Surface Mount Unit for 600x600 Arial Backlit Panel	-	-	-	-
10192	-	Surface Mount Unit for 1200x300 Arial Backlit Panel	-	-	-	-
10193	-	Surface Mount Unit for 1200x600 Arial Backlit Panel	-	-	-	-
10118	-	Suspension Kit for 600x600/1200x300 Arial Backlit Panel	-	-	-	-
08747	2.5	LED Self Test or Manual Emergency Pack	-	-	-	-
30020	-	Arial Multi Backlit LED Panel. Bulk pack (6) requires 12016/7	-	-	-	-
12106	20/26/30/36W	Driver for 30020	-	-	-	-
12107	36W	Driver for 30020	-	-	-	-

\*Lumens based on 4000K  
 Emergency versions must be tested in line with the requirements of BS5266, failure to do so may effect battery life and warranty.



# Arialmulti

## IP65 Backlit LED Panel

The IP65 version of our Arial Multi Backlit LED Panel is an ideal product for areas that may contain moisture such as changing rooms, locker rooms & commercial kitchen environments.

- Front face IP65
- Professional Backlit LED panel
- 0-10V Dimming or DALI Dimming options available
- TPb
- BELL Driver
- Anti-twist frame
- Emergency panels with 5 year battery warranty available



LMR80: Maximum 20% of lumen depreciation over rated hours.  
B10: Maximum 10% of fittings failure rate over rated hours





# IP65 Backlit LED Panel

Technical Specification	
Construction	Steel + PMMA
Driver	BELL
LED Chip	Philips
IP Rating	IP65 (Front face)
Operating Temp	0°C to +35°C
Input Voltage	220 - 240V
Power Factor	> 0.9
CRI	85 - Exceeds EU standard of Ra 80 for Colour Rendering Index
LMR	80 - Exceeds EU standard of 70 for Lumens Maintenance Ratio
L1A / L1B / L2A / L2B Compliant	Yes
Emergency Battery Type	NiCd 1 Year Emergency / LiFePO4 5 Year Emergency

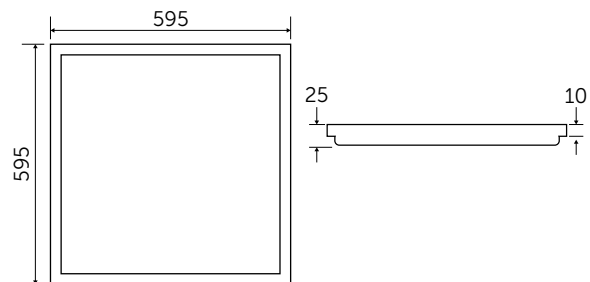

<sup>1</sup> Exceeds EU standard of 70 for Lumens Maintenance Ratio  
<sup>2</sup> Exceeds EU standard of RA 80 for Colour Rendering Index  
<sup>3</sup> Subject to terms & conditions (Contact Customer Service)

# IP65 Backlit LED Panel

Code	W	Description	Up to Lm/W	Lm	Temp	Hours
11780	20/26/30/36	Arial IP65 LED Backlit Panel - 600x600mm,	130	2600/3450 3900/4650	4000	50000
11781	20/26/30/36	Arial IP65 LED Backlit Panel - 600x600mm, Emergency, (1 Year Battery Guarantee)	130	2600/3450 3900/4650	4000	50000
11783	36	Arial IP65 LED Backlit Panel - 600x600mm, White, 0-10V Dim	130	4650	4000	50000
11784	36	Arial IP65 LED Backlit Panel - 600x600mm, White, Dali Dim	130	4650	4000	50000
08747	2.5	LED Emergency Pack (self + manual test)	-	-	-	-

Available on request:

- Emergency 0-10V Dim
- Emergency Dali Dim
- Emergency panels with 5 year battery warranty available

For further information call 01924 893380 or email [sales@bellighting.co.uk](mailto:sales@bellighting.co.uk)

Emergency versions must be tested in line with the requirements of BS5266, failure to do so may effect battery life and warranty.



**CASAMBI**  
Options Available

Index

# ArialT-pro multi

## Troffer Backlit LED CCT Panel

The Arial T-Pro Multi Backlit LED CCT Panel gives a unique twist on a standard LED panel. The contemporary slimline design and aesthetic light distribution works well in areas that would like to move away from the standard familiar panel we have all become accustomed to.

- High efficiency
- Aesthetic light distribution
- Contemporary slimline design
- TPa
- 0-10V Dimming and Dali dimming options available
- Casambi Enabled option available
- Emergency panels with 5-year battery guarantee available



LMR80: Maximum 20% of lumen depreciation over rated hours.  
B10: Maximum 10% of fittings failure rate over rated hours

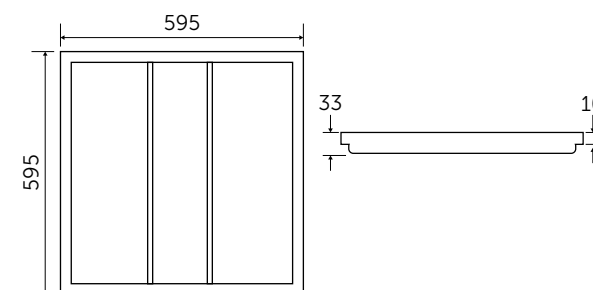

Wattage Selected	Colour Temp (K) Selected	Lumens (lm)
20W	4000	2550
26W	4000	2950
30W	4000	3300
36W	4000	3950

\*Lumens based on 4000K

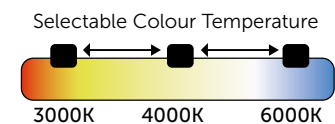

# ArialT-Pro Multi

## Troffer Backlit LED CCT Panel

### Technical Specification

Construction	Aluminium + PMMA
Driver	BELL
LED Chip	Philips
IP Rating	IP20
Operating Temp	0°C to +35°C
Input Voltage	220 - 240V
Power Factor	> 0.9
CRI	85 - Exceeds EU standard of Ra 80 for Colour Rendering Index
LMR	80 - Exceeds EU standard of 70 for Lumens Maintenance Ratio
L1A / L1B / L2A / L2B Compliant	Yes
Emergency Battery Type	NiCd 1 Year Emergency / LiFePO4 5 Year Emergency

Code	W	Description	up to Lm/W	Lm	Temp	Hours
11415	20/26/30/36	Arial T-Pro Multi UGR Troffer Panel - 600x600mm, CCT	110*	2250/2950 3300/3950	3/4/6K	50000
11416	20/26/30/36	Arial T-Pro Multi UGR Troffer Panel 600x600mm, CCT, Emergency 1 year	110*	2250/2950 3300/3950	3/4/6K	50000
11418	36	Arial T-Pro Multi UGR Troffer Panel - 600x600mm, CCT, 1-10v	110*	3950	3/4/6K	50000
11417	36	Arial T-Pro Multi UGR Troffer Panel - 600x600mm, CCT, Dali	110*	3950	3/4/6K	50000
08747	2.5	LED Emergency Pack (self + manual test)	-	-	-	-

Available on request:

- Emergency 0-10V Dim
- Emergency Dali Dim
- Emergency panels with 5 year battery warranty available

For further information call 01924 893380 or email [sales@belllighting.co.uk](mailto:sales@belllighting.co.uk)

\*Lumens based on 4000K  
Emergency versions must be tested in line with the requirements of BS5266, failure to do so may effect battery life and warranty.

<sup>1</sup> Exceeds EU standard of 70 for Lumens Maintenance Ratio  
<sup>2</sup> Exceeds EU standard of RA 80 for Colour Rendering Index  
<sup>3</sup> Subject to terms & conditions (Contact Customer Service)





# FirestayLED

CCT 4 colour / 2 wattage switchable

## Integrated LED Fixed / Centre Tilt Downlight

Our flagship downlight has received a major facelift for 2024! The Firestay CCT now includes a 4-way colour switch and 2-way wattage switch as standard. With an upgraded 10-year warranty, the new Firestay CCT is truly a fit and forget market leading downlight

- Firestay Certification: 30, 60 and 90 minute solid joist ceilings, 30 minute I-Joist & Metal Web ceiling systems
- IP65
- Front CCT/Wattage switch
- 8 in 1 Fixture, 4 colour temperatures, 2 wattages
- Includes white magnetic bezels
- Part B / C / E compliant
- IC rated up to 350mm insulation
- 60° beam angle
- Fixed Screw Terminal & Lever Tool-Free Terminal options
- Spacer plate options available



LMR80: Maximum 20% of lumen depreciation over rated hours.  
B10: Maximum 10% of fittings failure rate over rated hours

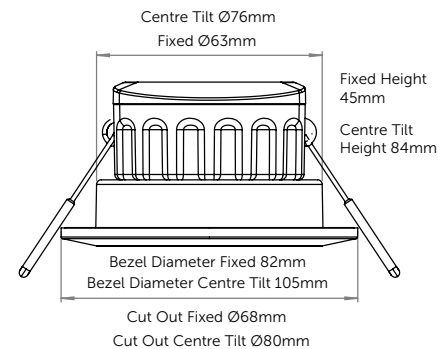

Wattage Selected	Colour Temp (K) Selected	Lumens (lm)	Candelas (cd)
5W	2700	570	550
	3000	590	550
	4000	635	580
7W	6000	625	615
	2700	745	640
	3000	775	670
7W	4000	830	720
	6000	820	715



## Integrated LED Fixed / Centre Tilt Downlight

The Firestay LED CCT has an easily accessible colour selectable switch located under the bezel on the front of the downlights. Simply move the switch to select your colour temperature option.

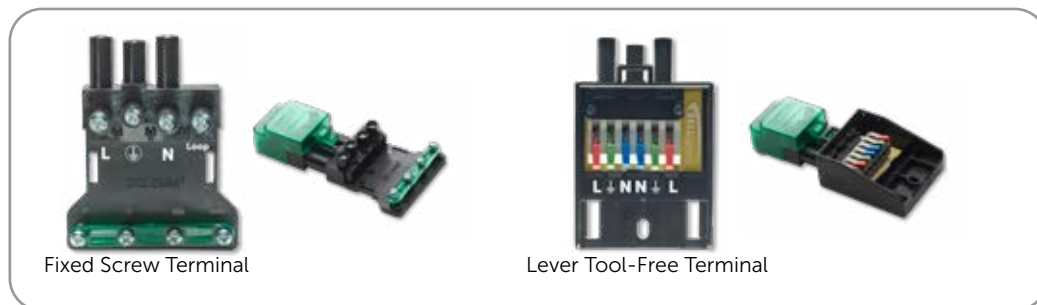
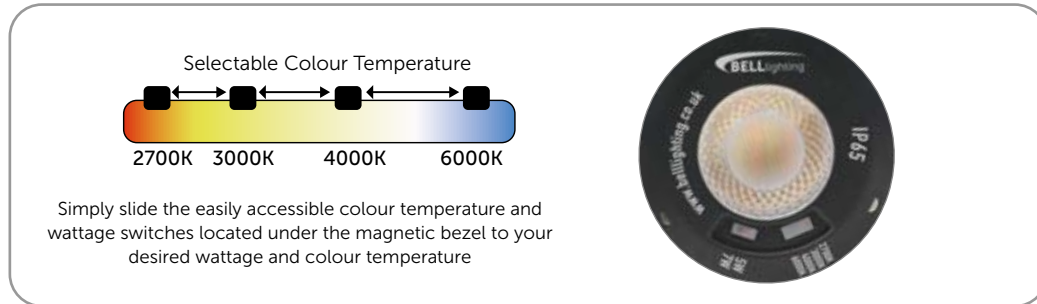

### Technical Specification

Construction	Die-Cast Aluminium
Driver	On Board
LED Chip	Epistar
IP Rating	IP65
Operating Temp	-5°C to +35°C
Input Voltage	220 - 240V
Power Factor	> 0.9
CRI	85 - Exceeds EU standard of Ra 80 for Colour Rendering Index
LMR	80 - Exceeds EU standard of 70 for Lumens Maintenance Ratio

Code	Description	Colour Temperature	Lm	Cd	Beam <sup>0</sup>	Hrs
08187V2	5/7W Firestay LED CCT 4 Way Selectable Colour Switch Downlight Dimmable, Plug & Play, 60° Beam Angle. Fixed Screw Terminal	2700/3000 4000/6000K	570-830	550-720	60°	50000
10510V2	5/7W Firestay LED CCT 4 Way Selectable Colour Switch Downlight Dimmable, Plug & Play, 60° Beam Angle. Lever Tool-Free Terminal	2700/3000 4000/6000K	570-830	550-720	60°	50000
10565	Satin Magnetic Bezel for above	-	-	-	-	-
10560	Chrome Magnetic Bezel for above	-	-	-	-	-
10561	Brass Magnetic Bezel for above	-	-	-	-	-
10562	Antique Brass Magnetic Bezel for above	-	-	-	-	-
10563	Matt Black Magnetic Bezel for above	-	-	-	-	-
10564	White Magnetic Bezel for above	-	-	-	-	-
08193	White Spacer Plate for above (100mm cut out)	-	-	-	-	-
08194	Satin Spacer Plate for above (100mm cut out)	-	-	-	-	-
08196	Emergency Pack for above	-	-	-	-	-
10803	Smart Universal LED Trailing/Leading Edge Dimmer Module	-	-	-	-	-
08190V2	7W Firestay CCT 4 Way Selectable Colour Switch Center Tilt LED Downlight, Dimmable, Plug & Play, 40° Beam Angle. Screw Fix Termination	3/4/6000K	550-600	660	40°	50000
08200	Chrome Magnetic Bezel for above	-	-	-	-	-
08201	Brass Magnetic Bezel for above	-	-	-	-	-
08202	Antique Brass Magnetic Bezel for above	-	-	-	-	-
08203	Matt Black Magnetic Bezel for above	-	-	-	-	-
08196	Emergency Pack for Firestay LED Downlights	-	-	-	-	-
10803	Smart Universal LED Trailing/Leading Edge Dimmer Module	-	-	-	-	-

Emergency versions must be tested in line with the requirements of BS5266, failure to do so may effect battery life and warranty.

<sup>1</sup> Exceeds EU standard of 70 for Lumens Maintenance Ratio  
<sup>2</sup> Exceeds EU standard of RA 80 for Colour Rendering Index  
<sup>3</sup> Subject to terms & conditions (Contact Customer Service)

# Firestayprimo

CCT 4 COLOUR / 3 WATTAGE SWITCHABLE

## Integrated LED Fixed Downlight

The Firestay Primo LED CCT is a High Output Downlight ideal for high ceilings or any project requiring high intensity light, 4 way colour and 3 wattages switchable straight out of the box.

With a 7 year product warranty, the front facing switch enables the user to seamlessly change the colour temperature (2700/3000/4000/6000K) to suit the mood of any space while the driver mounted wattage switch enable you to instantly dictate the light level of any commercial or residential premises.

- Firestay Certification: 30, 60 and 90 minute solid joist ceilings, 30 minute I-Joist & Metal Web ceiling systems
- IP65
- Front CCT switch
- 12 in 1 Fixture: 4 colour temperatures, 3 wattages
- White, Satin, Chrome, Brass, Antique Brass & Matt Black bezels available
- Part B / C / E compliant
- IC rated
- Tool-Free termination
- 60° Beam Angle
- Spacer plate options available



LMR80: Maximum 20% of lumen depreciation over rated hours.  
B10: Maximum 10% of fittings failure rate over rated hours

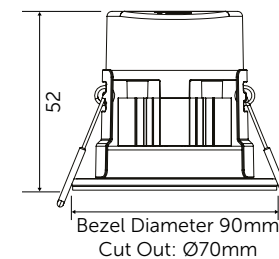

Wattage Selected	Colour Temp (K) Selected	Lumens (lm)	Candelas (cd)
10W	2700	1080	885
	3000	1115	905
	4000	1170	935
	6000	1165	955
8W	2700	955	780
	3000	980	790
	4000	1025	815
	6000	1040	850
6W	2700	720	590
	3000	730	595
	4000	760	605
	6000	765	625

IC Rated up to 350mm insulation  
Bezels sold separately

[www.belllighting.co.uk](http://www.belllighting.co.uk)

[technical@belllighting.co.uk](mailto:technical@belllighting.co.uk)  
[sales@belllighting.co.uk](mailto:sales@belllighting.co.uk)



# Firestayprimo

CCT 4 COLOUR / 3 WATTAGE SWITCHABLE

## Integrated LED Fixed Downlight

The Firestay Primo LED CCT has an easily accessible colour selectable switch located under the bezel on the front of the downlights. Simply move the switch to select your colour temperature option.

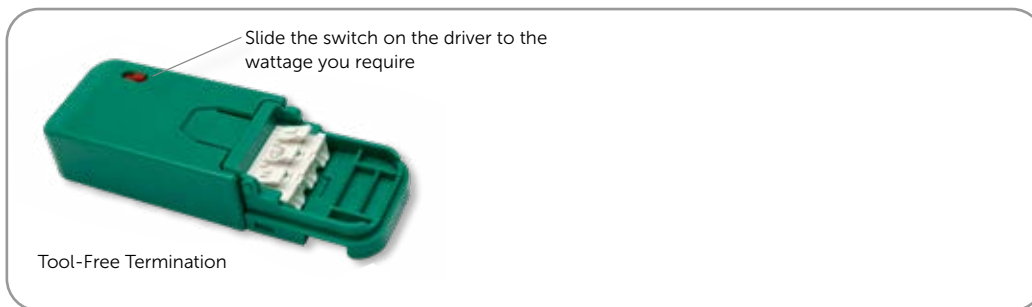
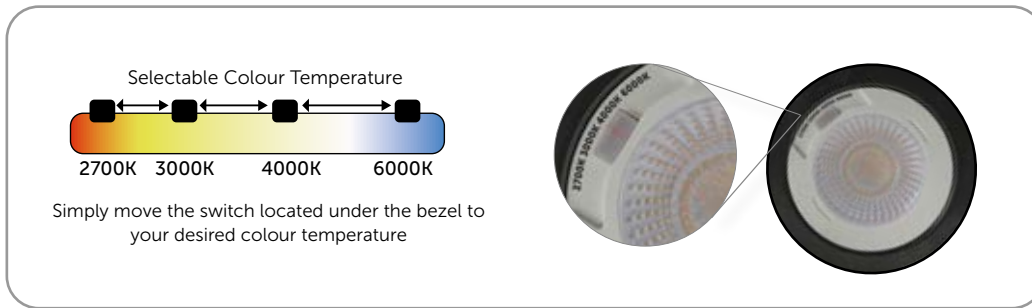

# Firestayprimo

CCT 4 COLOUR / 3 WATTAGE SWITCHABLE

### Technical Specification

Construction	Die-Cast Aluminium
Driver	BELL
LED Chip	Epistar
IP Rating	IP65
Operating Temp	-5°C to +35°C
Input Voltage	220 - 240V
Power Factor	> 0.9
CRI	85 - Exceeds EU standard of Ra 80 for Colour Rendering Index
LMR	80 - Exceeds EU standard of 70 for Lumens Maintenance Ratio

Code	Description	Colour Temperature	Lm	Cd	Beam <sup>0</sup>	Hrs
11390	6/8/10W Firestay Primo LED CCT Switchable Wattage Downlight Dim, CCT, P&P, 60° Beam Angle Tool Free Termination	2.7/3/4/6000	720 - 1170	590-955	60°	50000
11371	Matt White Bezel for above	-	-	-	-	-
11372	Satin Bezel for above	-	-	-	-	-
11373	Chrome Bezel for above	-	-	-	-	-
11374	Brass Bezel for above	-	-	-	-	-
11375	Antique Brass Bezel for above	-	-	-	-	-
11376	Matt Black Bezel for above	-	-	-	-	-
08196	Emergency Pack for above	-	-	-	-	-

<sup>1</sup> Exceeds EU standard of 70 for Lumens Maintenance Ratio  
<sup>2</sup> Exceeds EU standard of RA 80 for Colour Rendering Index  
<sup>3</sup> Subject to terms & conditions (Contact Customer Service)



# Integrated LED Fixed /Centre Tilt Downlight

The Firestay Duo LED CCT is a High Output Downlight ideal for high ceilings or any project requiring high intensity light, 4 way colour and 2 wattages switchable straight out of the box.

With a 8 year product warranty, the front facing switch enables the user to seamlessly change the colour temperature (2700/3000/4000/6000K) to suit the mood of any space while the wattage switch enables you to instantly dictate the light level of any commercial or residential premises.

- Firestay Certification: 30, 60 and 90 minute solid joist ceilings, 30 minute I-Joist & Metal Web ceiling systems
- IP65
- Front CCT switch
- 8 in 1 Fixture: 4 colour temperatures, 2 wattages
- White, Satin, Chrome, Brass, Antique Brass & Matt Black bezels available
- Part B / C / E compliant
- Lever Tool-Free Terminal
- 60° Beam Angle
- Spacer plate options available



LMR80: Maximum 20% of lumen depreciation over rated hours.  
 B10: Maximum 10% of fittings failure rate over rated hours

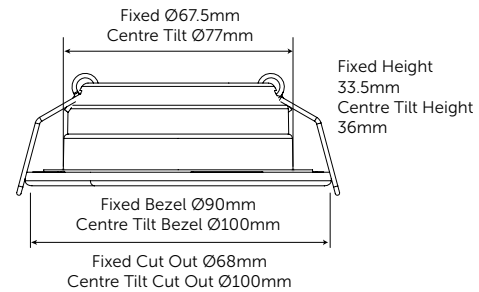

Wattage Selected	Colour Temp (K) Selected	Lumens (lm)	Candelas (cd)
4W	2700	475	380
	3000	495	400
	4000	525	415
	6000	540	425
6W	2700	640	520
	3000	671	540
	4000	725	570
	6000	740	580

# Firestay Duo

CCT 4 COLOUR / 2 WATTAGE SWITCHABLE

## Integrated LED Fixed / Centre Tilt Downlight

The Firestay Duo LED has a 2 easily accessible colour and wattage switches located under the bezel on the front of the downlight. Simply move the switches to select your colour temperature & wattage option.

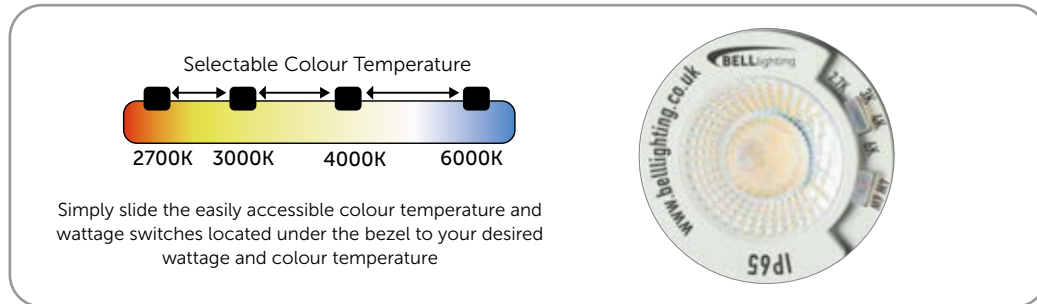

# Firestay Duo

CCT 4 COLOUR / 2 WATTAGE SWITCHABLE

Technical Specification	
Construction	Die-Cast Aluminium
Driver	BELL
LED Chip	Epistar
IP Rating	IP65
Operating Temp	-5°C to +35°C
Input Voltage	220 - 240V
Power Factor	> 0.9
CRI	85 - Exceeds EU standard of Ra 80 for Colour Rendering Index
LMR	80 - Exceeds EU standard of 70 for Lumens Maintenance Ratio

Code	Description	Colour Temperature	Lm	Cd	Beam <sup>o</sup>	Hrs
11370V2	4/6W Firestay Duo LED CCT Switchable Wattage Fixed Downlight, CCT, P&P, 60° Beam Lever Tool-Free Terminal	2.7/3/4/6000	475-740	380-580	60°	50000
11377V2	Contractor Pack containing 10X above downlights + white bezels	2.7/3/4/6000	475-740	380-580	60°	50000
11372	Satin Bezel for above	-	-	-	-	-
11371	Matt White Bezel for above	-	-	-	-	-
11373	Chrome Bezel for above	-	-	-	-	-
11374	Brass Bezel for above	-	-	-	-	-
11375	Antique Brass Bezel for above	-	-	-	-	-
11376	Matt Black Bezel for above	-	-	-	-	-
08196	Emergency Pack for above	-	-	-	-	-
11380V2	4/6W Firestay Duo LED CCT Switchable Wattage, Centre Tilt Downlight, CCT, P&P, 60° Beam Angle. Tool Free Termination	2.7/3/4/6000	415-635	415-565	60°	50000
11381	Matt White Bezel for above	-	-	-	-	-
11382	Satin Bezel for above	-	-	-	-	-
11383	Chrome Bezel for above	-	-	-	-	-
11384	Brass Bezel for above	-	-	-	-	-
11385	Antique Brass Bezel for above	-	-	-	-	-
11386	Matt Black Bezel for above	-	-	-	-	-
08196	Emergency Pack for above	-	-	-	-	-

<sup>1</sup> Exceeds EU standard of 70 for Lumens Maintenance Ratio  
<sup>2</sup> Exceeds EU standard of RA 80 for Colour Rendering Index  
<sup>3</sup> Subject to terms & conditions (Contact Customer Service)





IC Rated up to 350mm insulation  
 Bezel & LED CCT Geo-Mod® sold separately

[www.belllighting.co.uk](http://www.belllighting.co.uk)

Index

## LED Sustainable Modular Downlight

The Firestay Geo® patented technology has been developed to be energy saving while incorporating a fully circular economy design.

- Zero land fill, 90% of all material used on this product will be re-used and re-manufactured
- Firestay Certification: 30, 60 and 90 minute solid joist ceilings, 30 minute I-Joist & Metal Web ceiling systems
- TM66 Certified (Excellent Circularity)
- 2700/3000/4000/6000K Colour selectable
- White, Satin, Chrome, Brass, Antique Brass & Matt Black bezels available
- The Geo-Mod® is dimmable
- The Geo-Mod® enables the end user to quick fix and replace the CCT LED unit at the end of product life. Simply return the Geo-Mod® as per instructions on the unit.



LMR80: Maximum 20% of lumen depreciation over rated hours.  
 B10: Maximum 10% of fittings failure rate over rated hours



Patents GB2514685/GB2303902

The Geo-Mod® (sold separately) has been designed so at the end of life it can be returned to the manufacturer to be re-used and re-manufactured saving the need to recycle 90% of the product.



The housing has been designed to remain in the ceiling for life removing any need for recycling or possibility for landfill disposal.

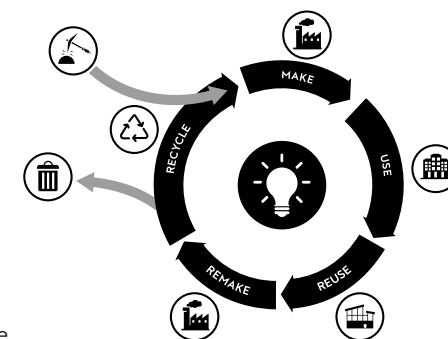

Packaging conforms to latest FSC standards



[technical@belllighting.co.uk](mailto:technical@belllighting.co.uk)  
[sales@belllighting.co.uk](mailto:sales@belllighting.co.uk)

**FirestayGeo®**  
Modular Downlight

## LED Sustainable Modular Fixed Downlight

The Firestay Geo® has an easily accessible colour selectable switch located on the front of the Module. Simply move the switch to select your colour temperature.

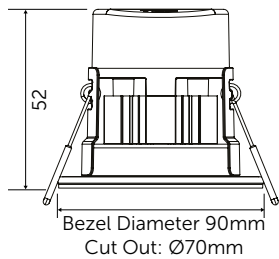
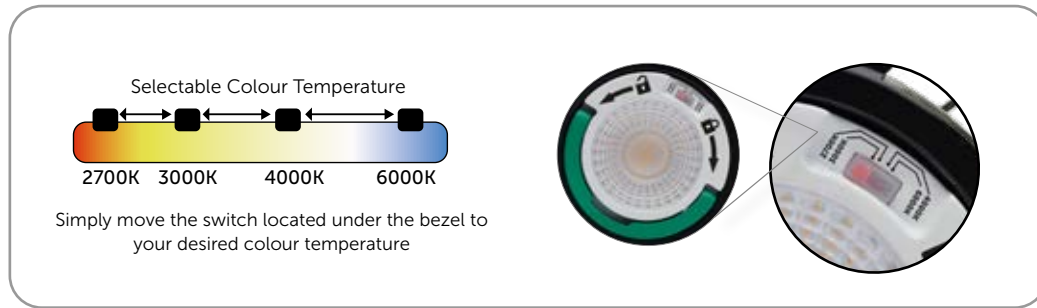

**FirestayGeo®**  
Modular Downlight

### Technical Specification

Construction	Die-Cast Aluminium/Recycled Polycarbonate
Driver	BELL
LED Chip	Epistar
IP Rating	IP65
Operating Temp	-5°C to +35°C
Input Voltage	220 - 240V
Power Factor	> 0.9
CRI	85 - Exceeds EU standard of Ra 80 for Colour Rendering Index
LMR	80 - Exceeds EU standard of 70 for Lumens Maintenance Ratio

Code	Description	Colour Temperature	Lm	Cd	Beam <sup>0</sup>	Hrs
11391	Firestay Geo® LED Sustainable Modular Downlight Housing	-	-	-	-	-
11392	5.5W Firestay Geo® LED Sustainable, Dimmable Module - CCT	2.7/3/4/6000K	600-650	490-530	60	50000
11371	White Bezel for above	-	-	-	-	-
11372	Satin Bezel for above	-	-	-	-	-
11373	Chrome Bezel for above	-	-	-	-	-
11374	Brass Bezel for above	-	-	-	-	-
11375	Antique Brass Bezel for above	-	-	-	-	-
11376	Black Bezel for above	-	-	-	-	-

<sup>1</sup> Exceeds EU standard of 70 for Lumens Maintenance Ratio  
<sup>2</sup> Exceeds EU standard of RA 80 for Colour Rendering Index  
<sup>3</sup> Subject to terms & conditions (Contact Customer Service)



IC Rated up to 350mm insulation

[www.belllighting.co.uk](http://www.belllighting.co.uk)

## Firestay LED Anti-Glare CCT Fixed Downlight

The Firestay LED Anti-Glare CCT Fixed Downlight 4 Way Colour Switch Downlight is one of our most innovative products within the Firestay range. Colour selectable as standard with a 7 year warranty. Firestay LED Anti-Glare CCT Fixed Downlight 4 Way Colour Switch Downlight distributes light evenly and eliminates glare, perfect for high end domestic and hospitality installations.

Colour selectable switch enables the user to seamlessly change the colour temperature to suit the mood of any space.

- 4 colour temperatures: 2700/3000/4000/6000K
- White Low Profile Bezel
- White reflector available
- Part B / C / E compliant
- IC Rated
- 45° beam angle



LMR80: Maximum 20% of lumen depreciation over rated hours.  
B10: Maximum 10% of fittings failure rate over rated hours

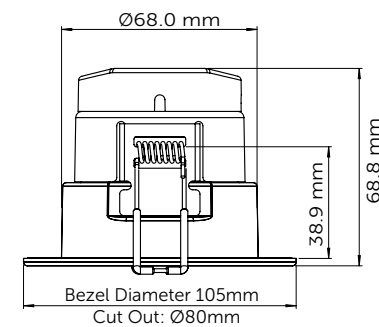



## Firestay LED Anti-Glare CCT Fixed Downlight

The Firestay LED CCT has an easily accessible colour selectable switch located under the bezel on the front of the downlights. Simply move the switch to select your colour temperature option.

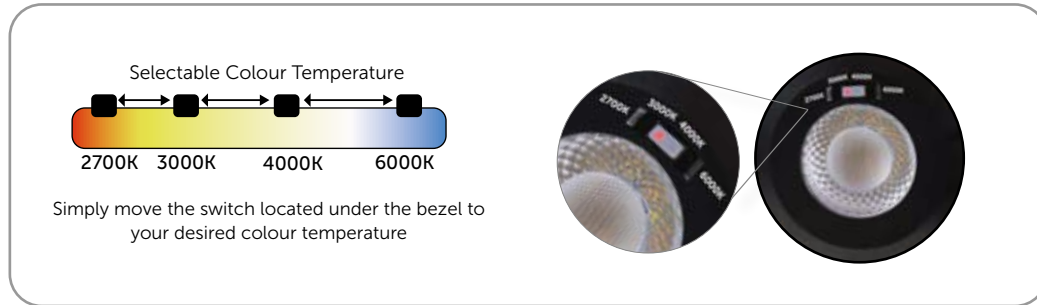

Technical Specification	
Construction	Die-Cast Aluminium
Driver	BELL
LED Chip	Epistar
IP Rating	IP65
Operating Temp	-5°C to +35°C
Input Voltage	200 - 240V
Power Factor	> 0.9
CRI	85 - Exceeds EU standard of Ra 80 for Colour Rendering Index
LMR	80 - Exceeds EU standard of 70 for Lumens Maintenance Ratio

Code	Description	Colour Temperature	Lm	Cd	Beam <sup>o</sup>	Hrs
10525	7W Firestay LED CCT Anti Glare 4 Way Selectable Colour Switch Downlight Dimmable, 45° Beam Angle. Tool Free Termination	2.7/3/4/6000K	360-400	600-660	45°	50000
10526	White Reflector for above	-	-	-	-	-

<sup>1</sup> Exceeds EU standard of 70 for Lumens Maintenance Ratio  
<sup>2</sup> Exceeds EU standard of RA 80 for Colour Rendering Index  
<sup>3</sup> Subject to terms & conditions (Contact Customer Service)





IC Rated up to 350mm insulation

[www.belllighting.co.uk](http://www.belllighting.co.uk)

## Firestay LED Anti-Glare CCT Centre Tilt Downlight

The Firestay LED Anti-Glare CCT Centre-Tilt 4 Way Colour Switch Downlight is one of our most innovative products within the Firestay range. Colour selectable as standard with a 7 year warranty. The Firestay LED Anti-Glare CCT Centre-Tilt 4 Way Colour Switch Downlight distributes light evenly and eliminates glare, perfect for high end domestic and hospitality installations.

Colour selectable switch enables the user to seamlessly change the colour temperature to suit the mood of any space.

- 4 colour temperatures: 2700/3000/4000/6000K
- White Low Profile Bezel
- White reflector available
- Part B / C / E compliant
- IC Rated
- 40° beam angle
- Dali Dim version available



LMR80: Maximum 20% of lumen depreciation over rated hours.  
 B10: Maximum 10% of fittings failure rate over rated hours

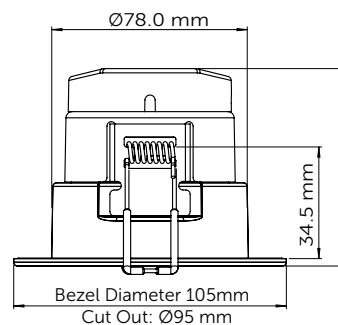



## Firestay LED Anti-Glare CCT Centre Tilt Downlight

Firestay LED Anti-Glare CCT Fixed Downlight has an easily accessible colour selectable switch located at the rear of the fitting. Simply move the switch to select your colour temperature option.

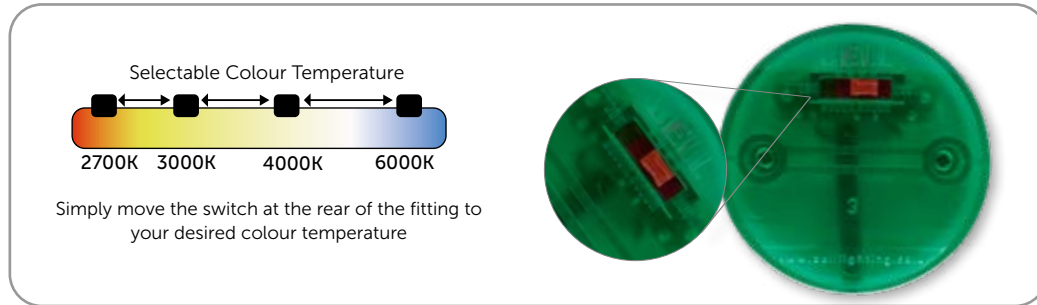

### Technical Specification

Construction	Die-Cast Aluminium
Driver	BELL
LED Chip	Epistar
IP Rating	IP65
Operating Temp	-5°C to +35°C
Input Voltage	220 - 240V
Power Factor	> 0.9
CRI	85 - Exceeds EU standard of Ra 80 for Colour Rendering Index
LMR	80 - Exceeds EU standard of 70 for Lumens Maintenance Ratio

Code	Description	Colour Temperature	Lm	Cd	Beam°	Hrs
10527	7W Firestay LED Anti-Glare Center Tilt CCT Downlight - White Bezel with Black Reflector, Tool Free Termination	2.7/3/4/6000	360-400	600-685	40°	50000
08196	Emergency Pack for above	-	-	-	-	-
10526	White Reflector for above	-	-	-	-	-

<sup>1</sup> Exceeds EU standard of 70 for Lumens Maintenance Ratio  
<sup>2</sup> Exceeds EU standard of RA 80 for Colour Rendering Index  
<sup>3</sup> Subject to terms & conditions (Contact Customer Service)



IC Rated up to 350mm insulation

[www.belllighting.co.uk](http://www.belllighting.co.uk)

## Integrated LED Fixed Downlight

The Firestay Integrated Fixed Downlight boasts a 3 year warranty and is supplied with white & satin bezels as standard.

- Firestay Certification: 30, 60 and 90 minute solid joist ceilings, 30 minute I-Joist & metal web ceiling systems
- IP65
- Part B/C/E compliant
- White bezel & magnetic satin bezel
- Part L compliant
- Easy Fit Magnetic Bezel



LMR80: Maximum 20% of lumen depreciation over rated hours.  
B10: Maximum 10% of fittings failure rate over rated hours

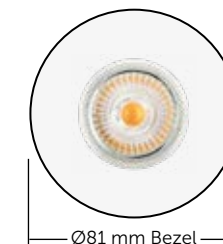
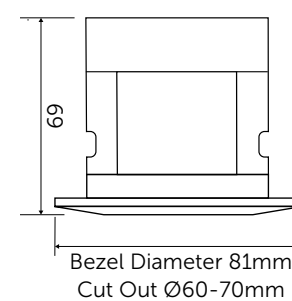

Quick Fix Connector  
Tool Free Termination

## Integrated LED Fixed Downlight

### Technical Specification

Construction	Aluminium
Driver	BELL
LED Chip	Samsung
IP Rating	IP65
Operating Temp	-5°C to +35°C
Input Voltage	220 - 240V
Power Factor	> 0.9
CRI	85 - Exceeds EU standard of Ra 80 for Colour Rendering Index
LMR	80 - Exceeds EU standard of 70 for Lumens Maintenance Ratio

Code	Description	Colour Temp	Lm	Cd	Beam <sup>1</sup>	Hrs
10499	6W Firestay LED Integrated Fixed Dimmable Downlight, incl White & Satin Bezels. Tool Free Termination	2700K	575	1025	40°	35000
10496	6W Firestay LED Integrated Fixed Dimmable Downlight, incl White & Satin Bezels. Tool Free Termination	2700K	560	500	60°	35000
10500	6W Firestay LED Integrated Fixed Dimmable Downlight, incl White & Satin Bezels. Tool Free Termination	3000K	580	1050	40°	35000
10497	6W Firestay LED Integrated Fixed Dimmable Downlight, incl White & Satin Bezels. Tool Free Termination	3000K	575	590	60°	35000
10501	6W Firestay LED Integrated Fixed Dimmable Downlight, incl White & Satin Bezels. Tool Free Termination	4000K	595	1200	40°	35000
10498	6W Firestay LED Integrated Fixed Dimmable Downlight, incl White & Satin Bezels. Tool Free Termination	4000K	590	655	60°	35000
10560	Chrome Magnetic Bezel for above	-	-	-	-	-
10561	Brass Magnetic Bezel for above	-	-	-	-	-
10562	Antique Brass Magnetic Bezel for above	-	-	-	-	-
10563	Matt Black Magnetic Bezel for above	-	-	-	-	-
10564	White Magnetic Bezel for above	-	-	-	-	-
10565	Satin Magnetic Bezel for above	-	-	-	-	-
08193	White Spacer Plate for above (100mm cut out)	-	-	-	-	-
08194	Satin Spacer Plate for above (100mm cut out)	-	-	-	-	-
08196	Emergency Pack for above	-	-	-	-	-
10803	Smart Universal LED Trailing/Leading Edge Dimmer Module	-	-	-	-	-

Emergency versions must be tested in line with the requirements of BS5266, failure to do so may effect battery life and warranty.

<sup>1</sup> Exceeds EU standard of 70 for Lumens Maintenance Ratio  
<sup>2</sup> Exceeds EU standard of RA 80 for Colour Rendering Index  
<sup>3</sup> Subject to terms & conditions (Contact Customer Service)







Index



IC Rated up to 270mm insulation

www.belllighting.co.uk

# Firestay Slim

## Integrated LED Fixed/Tilt Downlight

The most cost effective integrated downlight in the BELL range, the Firestay Slim comes with a 3 year quality warranty. Fixed and Centre Tilt options available with a choice of finishes and colour temperatures.

- Firestay Certification: 30, 60 and 90 minute solid joist ceilings, 30 minute I-Joist & Metal Web ceiling systems
- IP65 - Fixed Versions / IP44 - Tilt Version
- 30/60/90 minutes firestay
- Part B/C/E compliant
- Choice of finishes
- Dimmable
- Cut Out Ø55-68 mm
- Tool Free Connector



LMR80: Maximum 20% of lumen depreciation over rated hours.

B10: Maximum 10% of fittings failure rate over rated hours

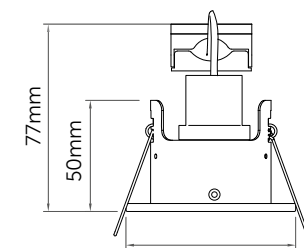

Bezel Diameter 81.5mm  
Cut Out Ø 55-68mm

Fixed Downlight

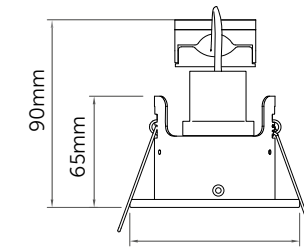

Bezel Diameter 81.5mm  
Cut Out Ø 55-68mm

Centre Tilt Downlight



Tool Free Connector  
2.5mm twin earth loop in /  
loop out push-fit connectors

## Integrated LED Fixed/Tilt Downlight

### Technical Specification

Construction	Pressed Steel
Driver	On Board
LED Chip	Samsung
IP Rating	Fixed IP65 / Centre Tilt IP44
Operating Temp	-5°C to +35°C
Input Voltage	220 - 240V
Power Factor	> 0.9
CRI	85 - Exceeds EU standard of Ra 80 for Colour Rendering Index
LMR	80 - Exceeds EU standard of 70 for Lumens Maintenance Ratio

Code	Description	Colour Temp	Lm	Beam <sup>0</sup>	Hrs
10675	5W Firestay Integrated LED Fixed Downlight White Bezel	3000K	500	60°	35000
10676	5W Firestay Integrated LED Fixed Downlight White Bezel	4000K	550	60°	35000
10677	5W Firestay Integrated LED Fixed Downlight Satin Bezel	3000K	462	60°	35000
10678	5W Firestay Integrated LED Fixed Downlight Satin Bezel	4000K	550	60°	35000
10679	5W Firestay Integrated LED Fixed Downlight Chrome Bezel	3000K	462	60°	35000
10680	5W Firestay Integrated LED Fixed Downlight Chrome Bezel	4000K	492	60°	35000
10681	5W Firestay Integrated LED Centre Tilt Downlight White Bezel	3000K	450	60°	35000
10682	5W Firestay Integrated LED Centre Tilt Downlight White Bezel	4000K	478	60°	35000
10683	5W Firestay Integrated LED Centre Tilt Downlight Satin Bezel	3000K	450	60°	35000
10684	5W Firestay Integrated LED Centre Tilt Downlight Satin Bezel	4000K	478	60°	35000
10685	5W Firestay Integrated LED Centre Tilt Downlight Chrome Bezel	3000K	450	60°	35000
10686	5W Firestay Integrated LED Centre Tilt Downlight Chrome Bezel	4000K	560	60°	35000

<sup>1</sup> Exceeds EU standard of 70 for Lumens Maintenance Ratio  
<sup>2</sup> Exceeds EU standard of RA 80 for Colour Rendering Index  
<sup>3</sup> Subject to terms & conditions (Contact Customer Service)





Index



GU10 Lamp & Bezels sold separately

[www.belllighting.co.uk](http://www.belllighting.co.uk)

# Firestayguardian

## Non Integrated Downlight

The Firestay Guardian Non Integrated Downlight gives you the freedom to choose your lamp and bezel without the need to replace the complete fitting. Available as Fixed, Centre Tilt & IP65 Showerlight with a choice of finishes and accessories.

- Firestay Certification: 30, 60 and 90 minute solid joist ceilings, 30 minute I-Joist ceiling systems
- Fixed / Centre Tilt / Showerlight IP65 Downlights
- Part B/C/E compliant
- Suitable for 240V lamps (GU10 lamp holder included)
- Loop in/out terminals for speed of installation
- Die-cast aluminium body
- Part L compliant with BELL Halo Elite/Halo Glass LED GU10
- Low voltage lampholder available separately (Code 09906)

One fitting to fit all standard type lamps. Simply choose a BELL lamp for the application required (See LED Lamps section)



Tool Free Connector  
2.5mm twin earth loop in /  
loop out push-fit connectors



## Non Integrated Downlight

Technical Specification	
Construction	Pressed Steel
LED Chip	n/a
IP Rating	IP65 (Showerlight)
Operating Temp	n/a
Input Voltage	n/a
Power Factor	n/a
CRI	n/a
LMR	n/a

Code	V	Description	Cut Out (mm)
11530	240	Firestay Guardian LED Non Integrated Fixed Downlight - No Bezel	68
11531	240	White Bezel for Fixed Downlight	68
11533	240	Satin Bezel for Fixed Downlight	68
11534	240	Chrome Bezel for Fixed Downlight	68
11535	240	Antique Brass Bezel for Fixed Downlight	68
11536	240	Brass Bezel for Fixed Downlight	68
11537	240	Matt White Bezel for Fixed Downlight	68
11538	240	Matt Black Bezel for Fixed Downlight	68
11539	240	Firestay Guardian LED Non Integrated Centre Tilt Downlight - No Bezel	78
11540	240	White Bezel for Center Tilt Downlight	78
11542	240	Satin Bezel for Center Tilt Downlight	78
11543	240	Chrome Bezel for Center Tilt Downlight	78
11544	240	Antique Brass Bezel for Center Tilt Downlight	78
11545	240	Brass Bezel for Center Tilt Firestay Downlight	78
11546	240	Matt White Bezel for Center Tilt Downlight	78
11547	240	Matt Black Bezel for Center Tilt Downlight	78
11548	240	Firestay Guardian LED Non Integrated IP65 Showerlight - No Bezel	69
11549	240	White Bezel for Showerlight	69
11551	240	Satin Bezel for Showerlight	69
11552	240	Chrome Bezel for Showerlight	69
11553	240	Antique Brass Bezel for Showerlight	69
11554	240	Brass Bezel for Showerlight	69
11555	240	Matt White Bezel for Showerlight	69
11556	240	Matt Black Bezel for Showerlight	69

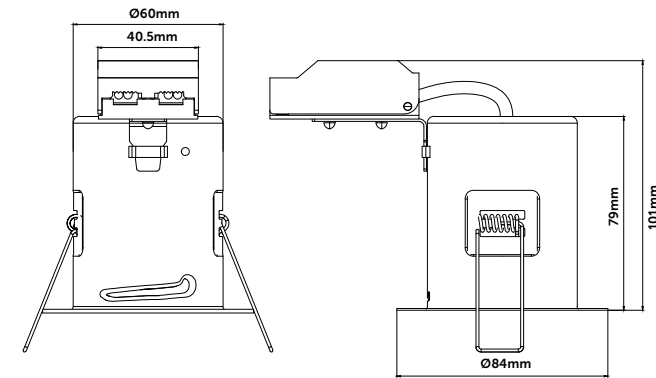

Fixed: Bezel Diameter 84mm Cut-Out: Ø68mm

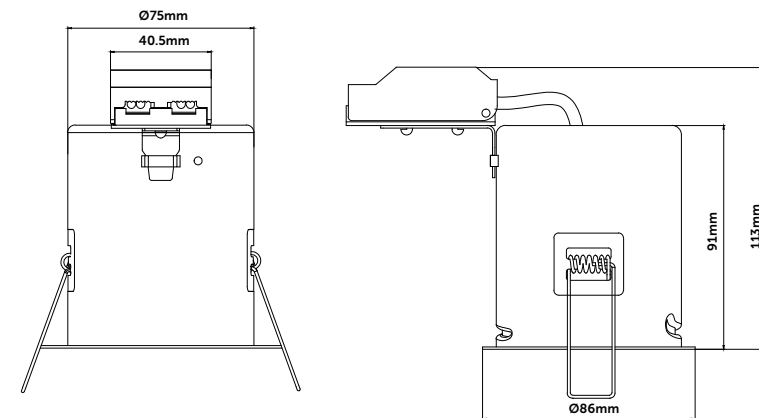

Centre Tilt: Bezel Diameter 86 mm Cut-Out: Ø78mm

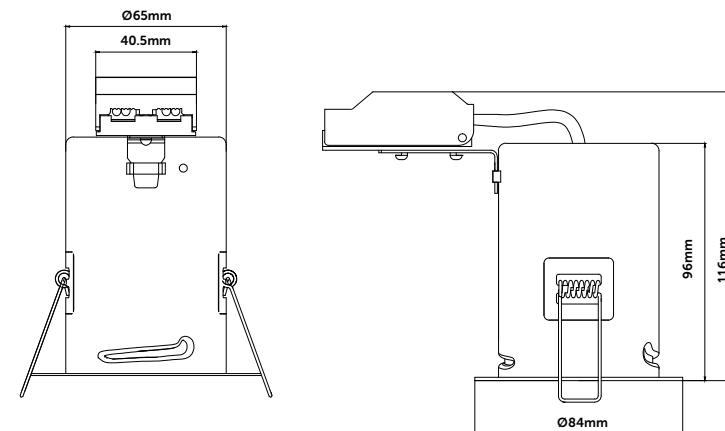

IP65 Showerlight : Bezel Diameter 86mm Cut-Out: Ø69mm

# Firestay Protector

## Non Integrated Downlight

The Firestay Protector Non Integrated Downlight gives you the freedom to choose your lamp without the need to replace the complete fitting. Available as Fixed, Centre Tilt & IP65 Showerlight with a choice of finishes and accessories.

- Firestay Certification: 30, 60 and 90 minute solid joist ceilings, 30 minute I-Joist ceiling systems
- Fixed / Centre Tilt / Showerlight IP65 Downlights
- Part B/C/E compliant
- Suitable for 240V lamps (GU10 lamp holder included)
- Loop in/out terminals for speed of installation
- Die-cast aluminium body
- Part L compliant with BELL Halo Elite/Halo Glass LED GU10
- Low voltage lampholder available separately (Code 09906)

One fitting to fit all standard type lamps. Simply choose a BELL lamp for the application required (See LED Lamps section)



Tool Free Connector  
2.5mm twin earth loop in /  
loop out push-fit connectors



## Non Integrated Downlight

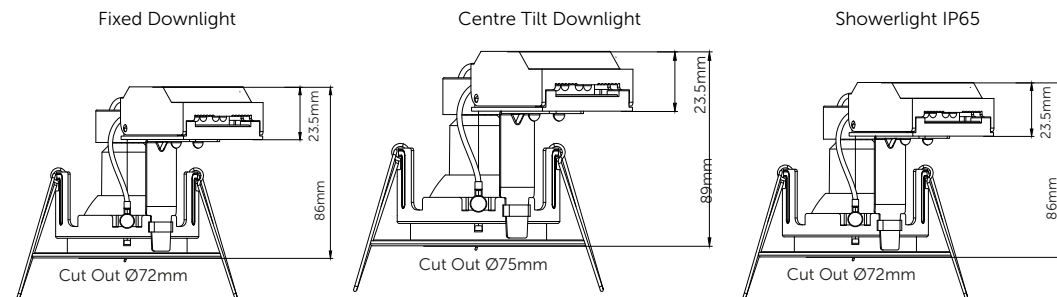

Code	V	Description	Finish	Cut Out (mm)
11850	240	Firestay Protector Open Back Non Integrated Fixed Downlight	White	72
11851	240	Firestay Protector Open Back Non Integrated Fixed Downlight	Matt White	72
11852	240	Firestay Protector Open Back Non Integrated Fixed Downlight	Black	72
11853	240	Firestay Protector Open Back Non Integrated Fixed Downlight	Satin	72
11854	240	Firestay Protector Open Back Non Integrated Fixed Downlight	Chrome	72
11855	240	Firestay Protector Open Back Non Integrated Fixed Downlight	Brass	72
11856	240	Firestay Protector Open Back Non Integrated Fixed Downlight	Antique Brass	72

Technical Specification	
Construction	Pressed Steel
LED Chip	n/a
IP Rating	IP65 (Showerlight)
Operating Temp	n/a
Input Voltage	n/a
Power Factor	n/a
CRI	n/a
LMR	n/a

Code	V	Description	Finish	Cut Out (mm)
11857	240	Firestay Protector Open Back Non Integrated Centre Tilt Downlight	White	75
11858	240	Firestay Protector Open Back Non Integrated Centre Tilt Downlight	Matt White	75
11859	240	Firestay Protector Open Back Non Integrated Centre Tilt Downlight	Black	75
11860	240	Firestay Protector Open Back Non Integrated Centre Tilt Downlight	Satin	75
11861	240	Firestay Protector Open Back Non Integrated Centre Tilt Downlight	Chrome	75
11862	240	Firestay Protector Open Back Non Integrated Centre Tilt Downlight	Brass	75
11863	240	Firestay Protector Open Back Non Integrated Centre Tilt Downlight	Antique Brass	75
11864	240	Firestay Protector Open Back Non Integrated Fixed Shower Downlight	White	72
11865	240	Firestay Protector Open Back Non Integrated Fixed Shower Downlight	Matt White	72
11866	240	Firestay Protector Open Back Non Integrated Fixed Shower Downlight	Black	72
11867	240	Firestay Protector Open Back Non Integrated Fixed Shower Downlight	Satin	72
11868	240	Firestay Protector Open Back Non Integrated Fixed Shower Downlight	Chrome	72
11869	240	Firestay Protector Open Back Non Integrated Fixed Shower Downlight	Brass	72
11870	240	Firestay Protector Open Back Non Integrated Fixed Shower Downlight	Antique Brass	72





Index





## Quick Fix Connector - 3/4 Pole

The BELL 3 or 4 Pole Quick Fix is a tool free connector designed for quick and easy installations.

- 20 Amp 250 Volt
- Robust Plug Connector
- Up to 3 x 2.5mm cables

Code	Description	Inner Box Qty	Outer Box Qty
08212	Quick Fix Connector - 3 Pole Connector Tool Free connection	50	200
08213	Quick Fix Connector - 4 Pole Connector Tool Free connection	50	200
08199	FREE Quick Fix Connector Trade Counter Display (For 08212)	-	-

Free display Box for 3 Pole Quick Fix Connector available on request.  
BULK packaging for quick access, no individual poly bags

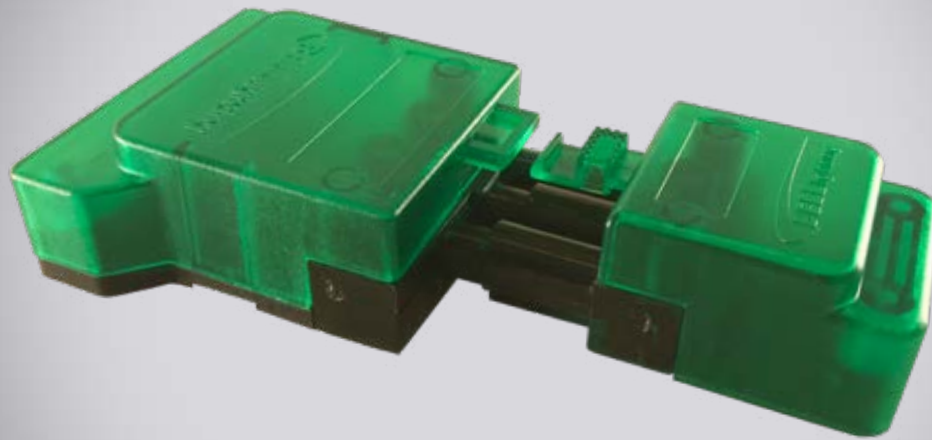



## LED Driver

15W LED Constant Voltage Line Driver 12V.

- Short-circuit protection
- Thermal protection
- Loop-in, loop-out primary wiring terminals
- EMC compliance - EN 55015, EN 61000, EN 61547

Code	Description	Box Qty
05100	15W LED Constant Voltage Line Driver 12V Short-circuit protection Thermal protection Loop-in, loop-out primary wiring terminals EMC compliance - EN 55015, EN 61000, EN 61547	1





## Smart Universal LED Trailing/Leading Edge Dimmer Module

Smooth, flicker free, silent, buzz free dimming and easy set up

- Completely silent dimming
- Smooth flicker free dimming
- Wide dimming ranging from 100% to 10%
- Compatible with most lamps and fittings in the market
- 5W - 100W LED lamps (10 lamps maximum)
- 5W - 150W including Incandescent, Halogen & CFL lamps

Code	Description	Box Qty
10803	<p>LED Dimmer Module            Ideal for replacing existing backplate dimmer modules when retro-fitting LED lamps or downlights            Suitable for dimming: LED / CFL / Halogen / Incandescent</p> <p>Resistive Load            GLS - Min 5W ~ Max 150W            Mains voltage Halogen - Min 5W ~ Max 150W</p> <p>Inductive Load            UNSUITABLE FOR dimmable magnetic transformer            Electronic transformer Min 10W ~ Max 150W</p> <p>LED Load            LED Dimmable lamps - Min 5W ~ Max 100W - 10 lamps maximum            LED Dimmable lamps - Min 5W ~ Max 120W - 10 lamps maximum</p> <p>Compact Fluorescent Load            CFL Dimmable lamps - Min 15W ~ Max 150W</p>	50

## LED Grid Dimmer

Smooth, flicker free, silent, buzz free dimming.

- Completely silent dimming
- Smooth flicker free dimming
- Wide dimming ranging from 100% to 10%
- Compatible with most lamps and fittings in the market
- 5W - 250W LED Lamps (30 lamps maximum)
- 10W - 400W including Incandescent, Halogen & CFL lamps
- Includes 9 adaptors
- Compatible with all standard grid plates
- Push on

Code	Description	Box Qty
10800	<p>LED Grid Dimmer Ideal for replacing existing Grid Dimmer modules when retro-fitting LED lamps or fittings Suitable for dimming: LED / CFL / Halogen / Incandescent</p> <p>Resistive Load GLS - Min 10W ~ Max 400W Mains voltage Halogen - Min 10W ~ Max 400W</p> <p>Inductive Load UNSUITABLE FOR Dimmable magnetic transformer Electronic transformer Min 10W ~ Max 150W</p> <p>LED Load LED Dimmable bulb - Min 5W ~ Max 250W - 30 lamps maximum LED Dimmable driver - Min 5W ~ Max 250W - 30 lamps maximum</p> <p>Compact Fluorescent Load CFL Dimmable bulb - Min 15W ~ Max 250W</p>	50

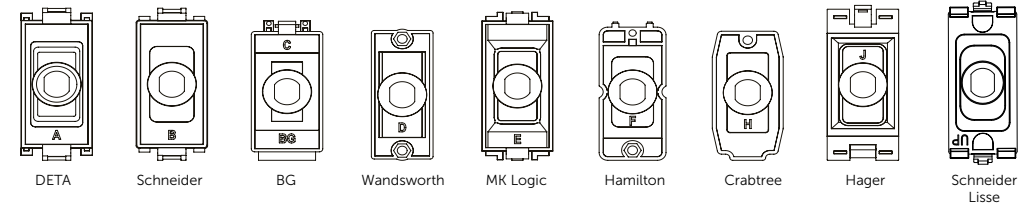

# Spectrum

## LED Emergency Hinged Exit Box

Our Spectrum LED Emergency Hinged Exit Box is one of our most popular emergency products. The tried and tested robust design and polycarbonate construction makes this exit box ideal for all commercial and industrial environments.

- Selectable Self Test or Manual Emergency Mode
- Hinged for quick and easy installation and maintenance
- Tool free termination
- Sleek, energy efficient design
- Different legend options available
- Suitable for commercial and industrial installations
- Viewing distance 25m



Auto Self Test Indicator. No requirement for manual key test (when switched to self test operation)

Normal operation: Green indicator illuminated

Battery failure: Red indicator flashes once every 3 seconds

Light source failure: Red indicator flashes twice every 3 seconds

Less than rated duration time: Red indicator flashes three times every 3 seconds.

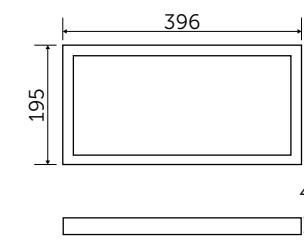

Index





## LED Emergency Hinged Exit Box

### Legend Options



09085 New (ISO) Legend Reversible  
Left & Right

09087 New (ISO)  
Legend Down

09086 New (ISO)  
Legend Up

### Technical Specification

Construction	Polycarbonate
LED Chip	Samsung
IP Rating	IP20
Operating Temp	0°C to +35°C
Input Voltage	220 - 240V
Power Factor	> 0.9
Battery	LiFeP04

Code	W	Description	Viewing Distance	Temp	Hours
09083V2	4	LED Emergency Hinged Exit Box including Up Legend.	25M	6500K	30000
09085	-	New (ISO) Legend Reversible Left & Right (spare accessory)	-	-	-
09087	-	New (ISO) Legend Down (spare accessory)	-	-	-
09086	-	New (ISO) Legend Up (spare accessory)	-	-	-

Must be tested in line with the requirements of BS5266, failure to do so may effect battery life and warranty.

<sup>1</sup> Exceeds EU standard of 70 for Lumens Maintenance Ratio  
<sup>2</sup> Exceeds EU standard of Ra 80 for Colour Rendering Index  
<sup>3</sup> Subject to terms & conditions (Contact Customer Service)



# Spectrum

## LED Emergency Exit Blade

The Spectrum LED Emergency Surface Exit Blade is one of our most cost-effective emergency products. With a viewing distance of 25m, this Maintained/Non maintained Exit Blade is viewable from both sides to ensure safe passage in the unlikely event of an emergency.

- Selectable Self Test or Manual Emergency Mode
- Sleek, low profile design
- Easy switching from non maintained to maintained via removable link
- Can be mounted to ceiling or wall
- Supplied with New Up Legend as standard
- Suitable for Commercial and Industrial installations
- Maintained / Non Maintained
- 25M Viewing Distance
- Viewable from both sides
- Recessing Kit option (Code 09048)



### Manual Push Test Indicator

Once activated, unit illuminates for 5 minutes to indicate fitting is functioning correctly. Key Test feature can also be used.

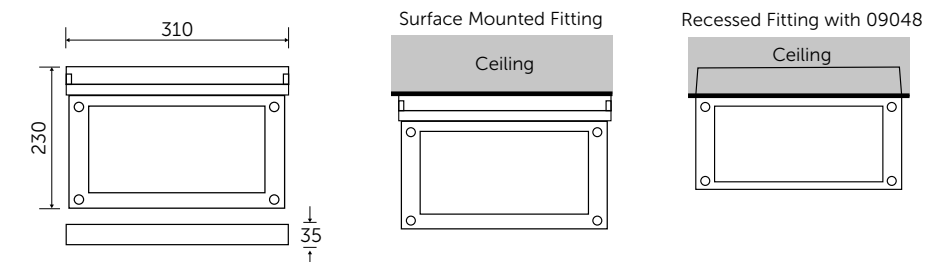

Rotating fixing, can be mounted to ceiling or wall at 90° angle

## LED Emergency Exit Blade

### Legend Options



09058 New (ISO)  
Left & right

09057 New (ISO)  
Legend Down

09056 New (ISO)  
Legend Up



09061 Old (Euro) Legend  
Left & Right

09060 Old (Euro)  
Legend Down

09059 Old (Euro)  
Legend Up

### Technical Specification

Construction	Polycarbonate
LED Chip	Samsung
IP Rating	IP20
Operating Temp	0°C to +35°C
Input Voltage	220 - 240V
Power Factor	> 0.9
Battery	LiFeP04

Code	W	Description	Viewing Distance	Temp	Hours
09012V2	2.5	LED Emergency Exit Blade Surface including Up Legend. Maintained/Non Maintained	25M	6500K	25000
09013	-	New Legend Left + Right for Exit Blade	-	-	-
09014	-	New Legend Down for Exit Blade	-	-	-
09015	-	New Legend Up for Surface Exit Blade (spare accessory)	-	-	-
09016	-	Old Legend Left + Right for Exit Blade	-	-	-
09017	-	Old Legend Down for Exit Blade	-	-	-
09018	-	Old Legend Up for Exit Blade	-	-	-
09048	-	Recessing kit for Emergency Surface Exit Blade (09012 & 09090)	-	-	-

Must be tested in line with the requirements of BS5266, failure to do so may effect battery life and warranty.





# Spectrum

## LED Emergency 6 in 1 Exit Blade

Surface / Suspended / Recessed / Wall / Parallel / Angled Mounting

The Spectrum 6 in 1 Exit Blade is a product unique to BELL. This product has the ability to be displayed in 6 different ways, so therefore is one of the most cost-effective, complete products on the market.

- Selectable Self Test or Manual Emergency Mode
- Suitable for commercial and industrial installations
- Different legend options available
- Maintained / Non Maintained
- Viewable from both sides
- Viewing distance 25m



Manual Push Test Indicator

Once activated, unit illuminates for 5 minutes to indicate fitting is functioning correctly. Key Test feature can also be used.

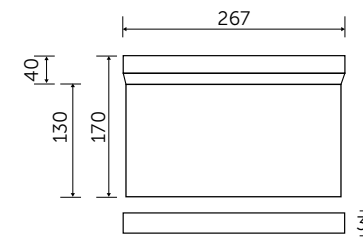

## LED Emergency 6 in 1 Exit Blade

### Legend Options



09067 New (ISO) Legend Reversible Left & Right

09068 (ISO) New Legend Down

### Technical Specification

Construction	Polycarbonate
LED Chip	Samsung
IP Rating	IP20
Operating Temp	0°C to +35°C
Input Voltage	220 - 240V
Power Factor	> 0.9
Battery	LiFeP04

Code	W	Description	Viewing Distance	Temp	Hours
09066V2	2	LED Emergency 6 in 1 Exit Blade. Including New (ISO) Up Legend	25M	6500K	30000
09067	-	New (ISO) Legend Reversible Left & Right	-	-	-
09068	-	New (ISO) Legend Down	-	-	-

Must be tested in line with the requirements of BS5266, failure to do so may effect battery life and warranty.

Index

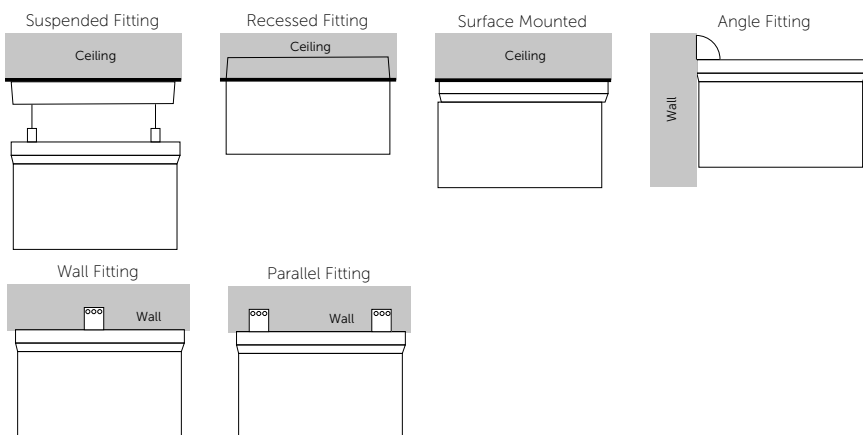



## LED Emergency Non Maintained Downlights

The 1W Spectrum Non Maintained Downlights have a green charge indicator and come complete with a sheathed battery pack. This IP20 rated fixture can be purchased for both Open Area and Corridor applications.

- Selectable Self Test or Manual Emergency Mode
- Open Area / Corridor versions
- Green charge indicator
- Complete with driver and sheathed battery pack
- Cut Out Ø32mm



### Technical Specification

Construction	Polycarbonate
LED Chip	Samsung
IP Rating	IP20
Operating Temp	0°C to +35°C
Input Voltage	220 - 240V
Power Factor	> 0.9
Battery	LiFeP04

Code	W	Description	Temp	Lm	Hours
09080	1	LED Emergency Non Maintained Downlight Open Area	6000K	120	30000
09081	1	LED Emergency Non Maintained Downlight Corridor	6000K	120	30000

See end of Emergency Lighting section for spacing tables

Must be tested in line with the requirements of BS5266, failure to do so may effect battery life and warranty.



# Spectrum

## Recessed Downlights

The 3W Spectrum Non Maintained Downlights have a dual colour charge indicator and come complete with a battery pack enclosed in a protective housing. This IP20 rated fixture can be purchased for both Open Area and Corridor applications.

- Selectable Self Test or Manual Emergency Mode
- Open Area / Corridor versions
- Dual colour charge indicator
- Complete with driver and fire rated battery pack
- 3W recessed



### Technical Specification

Construction	Polycarbonate
LED Chip	Samsung
IP Rating	IP20
Operating Temp	0°C to +35°C
Input Voltage	220 - 240V
Power Factor	> 0.9
Battery	LiFeP04

Code	W	Description	Temp	Lm	Hours
09030V2	3	LED Emergency Non Maintained Downlight Open Area	6500K	150	25000
09031V2	3	LED Emergency Non Maintained Downlight Corridor	6500K	150	25000

See end of Emergency Lighting section for spacing tables

Must be tested in line with the requirements of BS5266, failure to do so may effect battery life and warranty.







## 2W LED Emergency Non Maintained Downlight

The 2W Spectrum Auto Self Test Downlight is a 4 in 1 product which makes it one of the most versatile in the range. The downlight can be surface and recessed mounted and is supplied with both the Open Area & Corridor lenses.

- Selectable Self Test or Manual Emergency Mode
- Surface or recessed mount
- Suitable for open area or corridor
- Dual colour charge indicator, complete with driver and battery pack
- IP20



### Technical Specification

Construction	Polycarbonate
LED Chip	Samsung
IP Rating	IP40
Operating Temp	0°C to +35°C
Input Voltage	220 - 240V
Power Factor	> 0.9
Battery	LiFeP04

Code	W	Description	Temp	Lm	Hours
09126	2	LED Emergency Non Maintained Downlight	6500K	150	50000

See end of Emergency Lighting section for spacing tables

Must be tested in line with the requirements of BS5266, failure to do so may effect battery life and warranty.

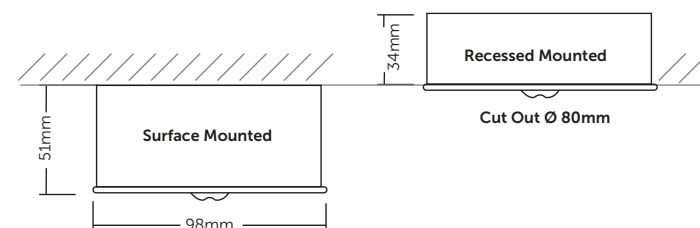



# Spectrum

## LED Emergency IP65 Twin Spot

The Spectrum IP65 Twin Spot is IP65 as standard. Supplied as both Self Test & Non Self Test, with 20mm side & rear entry and a 5 year warranty.

- Selectable Self Test or Manual Emergency Mode
- Long life & low maintenance
- Compact design & robust construction
- 20mm Side & rear entry



Auto Self Test Indicator. No requirement for manual key test (when switched to self test operation).

Normal operation: Green indicator illuminated

Battery failure: Red indicator: Single Flash

Light source failure: Red: Double Flash

Less than rated duration time: Red: Triple Flash

### Technical Specification

Construction	Polycarbonate
LED Chip	Samsung
IP Rating	IP65
Operating Temp	0°C to +35°C
Input Voltage	220 - 240V
Power Factor	> 0.9
Battery	LiFePO4

Code	W	Description	Temp	Lm	Hours
09088V2	12	LED Emergency Twin Spot IP65. Non Maintained - White	6500K	550	30000
09128	12	LED Emergency Twin Spot IP65. Non Maintained - Black	6500K	550	30000

See end of Emergency Lighting section for spacing tables

Must be tested in line with the requirements of BS5266, failure to do so may effect battery life and warranty.

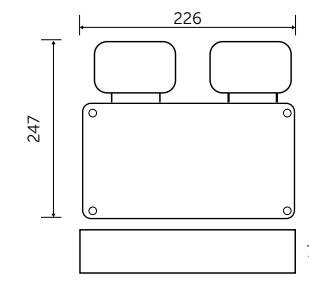

## LED Emergency Bulkhead / Recessed

Our most popular emergency bulkhead, the 3.3W IP65 bulkhead has a low-profile design and is suitable for both internal & external use. The optional exit blade accessory transforms this Emergency Bulkhead into an IP65 Exit Blade.

- Selectable Self Test or Manual Emergency Mode
- 3.3W IP65 Bulkhead
- Low profile slim design
- Long life
- Low maintenance
- Includes full set of New Legends
- Old Legends also available
- Internal/external use
- Viewing distance 25M
- Daylight 6500K
- 20mm Conduit entry
- Hinged Gear Tray for easy install
- Tool-Free termination
- 09046 Exit Blade Accessory available, when fitted this adapts 3.3W Bulkheads in to cost effective IP65 Exit Blades.

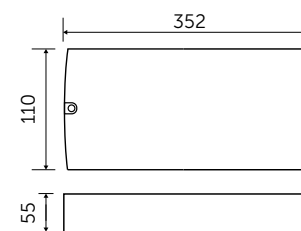

Cut Out: 350mm x 110mm  
When used with Semi  
Recessing Kit (09041)

Ceiling Mounted Fitting



Recessed Fitting



With optional 09046 Exit Blade attachment

# Spectrum

## LED Emergency Bulkhead / Recessed

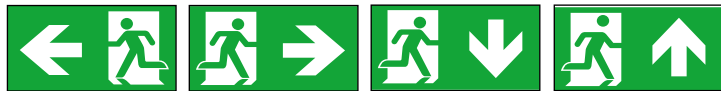

Includes all New (ISO) Legends



09043 Old (Euro) Legends Kit

### Technical Specification

Construction	Polycarbonate
LED Chip	Samsung
IP Rating	IP65
Operating Temp	0°C to +35°C
Input Voltage	220 - 240V
Power Factor	> 0.9
Battery	LiFePO4

Code	W	Description	Temp	Lm	Hours
09040V2	3.3	LED Emergency Bulkhead IP65. Maintained/Non Maintained Includes set of 4 New Legends	6500K	190	25000
09041	-	Semi Recessing Kit for LED Emergency Bulkhead	-	-	-
09043	-	Old Legend Kit for Emergency Bulkhead (Set of 4)	-	-	-
09046	-	Exit Blade Accessory	-	-	-

See end of Emergency Lighting section for spacing tables

Must be tested in line with the requirements of BS5266, failure to do so may effect battery life and warranty.



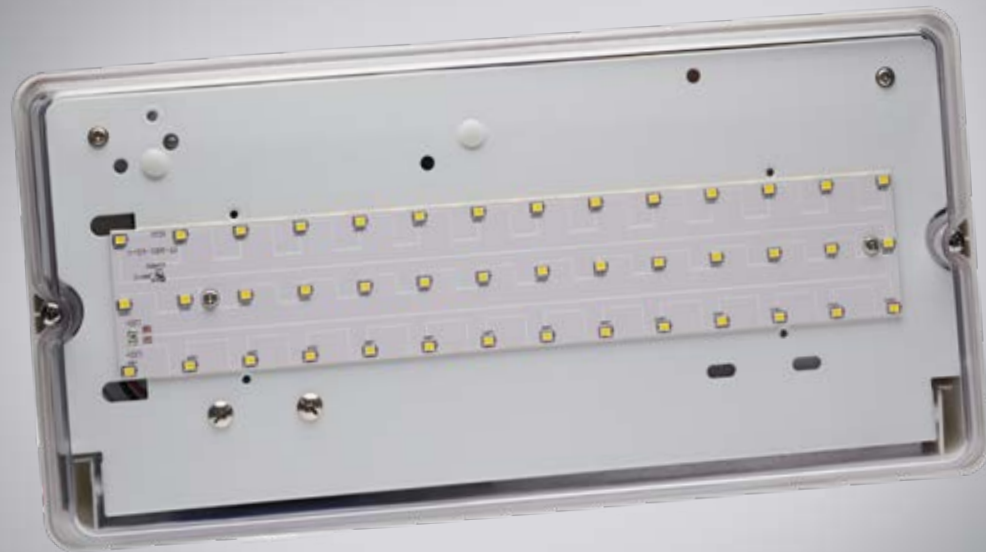

## LED High Power Emergency Bulkhead

The Spectrum Pro LED High Power Emergency Bulkhead is designed specifically for areas that require a substantial light output. With a light output of 1100 lumens, this high-powered emergency bulkhead is suitable for all commercial and industrial installations while boasting a 5 year warranty

- Selectable Self Test or Manual Emergency Mode
- 1100 Lm
- Suitable for commercial and industrial installations
- Non Maintained
- IP65
- 20mm conduit entry

### Technical Specification

Construction	Polycarbonate
LED Chip	Samsung
IP Rating	IP65
Operating Temp	0°C to +35°C
Input Voltage	220 - 240V
Power Factor	> 0.9
Battery	LiFePO4



Code	W	Description	Temp	Lm	Hours
09094V2	7	LED High Power Emergency Bulkhead	6500K	1100	50000

See end of Emergency Lighting section for spacing tables

Must be tested in line with the requirements of BS5266, failure to do so may effect battery life and warranty.

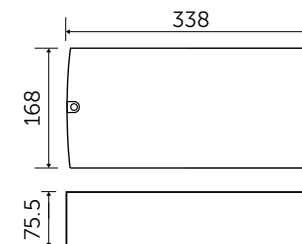

## Downlight Spacing Tables

3W Open Area Recessed Downlight (09030V2) Spacing Table				
Open Area (0.5 lux minimum)				
Mounting Height (M)	Transverse To Wall (M)	Transverse To Transverse (M)	Axial To Wall (M)	Axial To Axial (M)
2.5	3	7.8	-	-
4	3.6	9	-	-
6	3.6	10.8	-	-

3W Corridor Recessed Downlight (09031V2) Spacing Table				
Escape Route (1 lux across central line)				
Mounting Height (M)	Transverse To Wall (M)	Transverse To Transverse (M)	Axial To Wall (M)	Axial To Axial (M)
2.5	3	7.2	-	-
4	2.4	7.8	-	-
6	-	-	-	-



3W Corridor (09126) Spacing Table				
Escape Route (1 lux across central line)				
Mounting Height (M)	Transverse To Wall (M)	Transverse To Transverse (M)	Axial To Wall (M)	Axial To Axial (M)
2.5	3.8	7.2	-	-
4	5.0	10.8	-	-
6	-	-	-	-

3W Open Area (09065) Spacing Table				
Open Area (0.5 lux minimum)				
Mounting Height (M)	Transverse To Wall (M)	Transverse To Transverse (M)	Axial To Wall (M)	Axial To Axial (M)
2.5	3.2	6.6	3.2	6.6
4	3.8	9	3.8	9
6	3.6	11.2	3.6	11.2

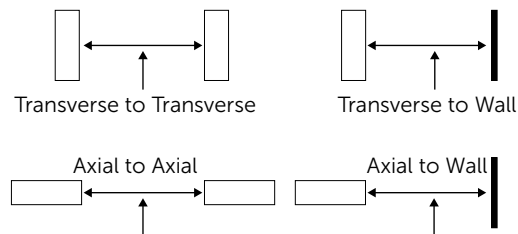

## Downlight Spacing Tables

3W Corridor Recessed Downlight (09075V2) Spacing Table				
Escape Route (1 lux across central line)				
Mounting Height (M)	Transverse To Wall (M)	Transverse To Transverse (M)	Axial To Wall (M)	Axial To Axial (M)
2.5	7.2	18	-	-
4	9	20.4	-	-
6	7.8	21.6	-	-

3W Open Area Recessed Downlight (09075V2) Spacing Table				
Open Area (0.5 lux minimum)				
Mounting Height (M)	Transverse To Wall (M)	Transverse To Transverse (M)	Axial To Wall (M)	Axial To Axial (M)
2.5	4.2	10.8	4.2	10.8
4	4.2	11.4	4.2	11.4
6	4.2	12.6	4.2	12.6



## Twin Spot Spacing Tables

12W Emergency Twin Spot (09088V2) Spacing Table				
Escape Route (1 lux across central line)				
Mounting Height (M)	Transverse To Wall (M)	Transverse To Transverse (M)	Axial To Wall (M)	Axial To Axial (M)
4	-	-	6.5	16
6	-	-	7	18
8	-	-	6.5	18.5

  

Open Area (0.5 lux minimum) Spacing Table				
Mounting Height (M)	Transverse To Wall (M)	Transverse To Transverse (M)	Axial To Wall (M)	Axial To Axial (M)
4	5	13	6.5	16
6	5.5	15	7	17
8	5.5	17	7.5	18



## Bulkhead Spacing Tables

3W Bulkhead (09040V2) Spacing Table				
Escape Route (1 lux across central line)				
Mounting Height (M)	Transverse To Wall (M)	Transverse To Transverse (M)	Axial To Wall (M)	Axial To Axial (M)
2.5	4.5	9.4	3.5	6
4	4.5	10	3.5	6.5
6	4.5	9.5	2.5	5.5
Open Area (0.5 lux minimum) Spacing Table				
Mounting Height (M)	Transverse To Wall (M)	Transverse To Transverse (M)	Axial To Wall (M)	Axial To Axial (M)
2.5	4	9	3.5	8
4	5	10	4	9
6	5	11.5	4	10

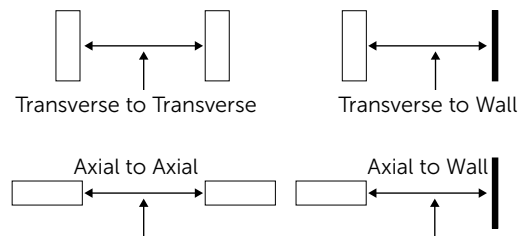

## Bulkhead Spacing Tables

7W High Power Bulkhead (09094V2) Spacing Table				
Escape Route (1 lux across central line)				
Mounting Height (M)	Transverse To Wall (M)	Transverse To Transverse (M)	Axial To Wall (M)	Axial To Axial (M)
4	7	16	7	16
6	8	20	8	20
8	8.5	22	8.5	22
Open Area (0.5 lux minimum) Spacing Table				
Mounting Height (M)	Transverse To Wall (M)	Transverse To Transverse (M)	Axial To Wall (M)	Axial To Axial (M)
4	6.5	16.5	6.5	16.5
6	7.5	18.5	7.5	18.5
8	8.5	23.5	8.5	23.5

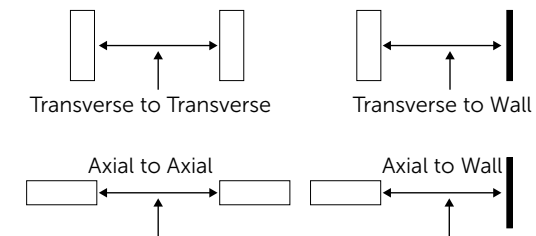





## LED GU10 Dimming



### LED Halo/Halo Elite GU10

- Energy saving benefits of LED
- Up to 112 Lm/W
- Rimless lens for improved aesthetics
- True fit GU10 size
- Suitable for fire rated and IP rated fixtures

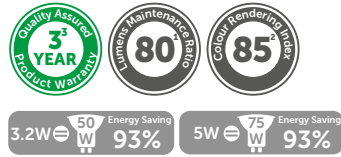

Sharp SMT Multi LED Chip

Precision moulded polycarbonate lens to ensure precise beam angles

High performance aluminium heat sink, rated to 45° ambient temperature

BELL designed IC Driver for enhanced dimming performance

Surge protected circuitry at 3kV



### LED Halo Glass/Halo Elite Glass GU10

Traditional halogen look with the energy saving benefits of LED

- True fit GU10 size
- High performance 86 Lm/W
- Suitable for fire rated and IP rated fixtures
- 38° beam angle
- High grade driver designed for smooth dimming at min & max load levels, operating effectively with rotary and digital dimming system

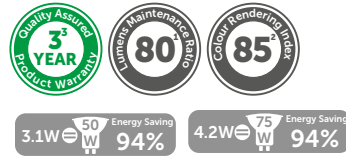

Precision moulded polycarbonate lens to ensure precise beam angles

Sharp SMT Multi LED Chip

Shatterproof frost glass casing for safety and improved aesthetics

Unique IC Switch Driver designed for optimum dimming and flicker free performance



<sup>1</sup> Exceeds EU standard of 70 for Lumens Maintenance Ratio  
<sup>2</sup> Exceeds EU standard of RA 80 for Colour Rendering Index  
<sup>3</sup> Subject to terms & conditions (Contact Customer Service)



## LED GU10 Dimming



3.2W LED Halo / 5W LED Halo Elite / 5W LED Halo Glass / 6W LED Halo Elite Glass

Smart Universal LED Trailing/Leading Edge Dimmer Module (Code 10803)	2 to 10
BELL Grid Dimmer (Code 10800)	2 to 20
Aurora DSP651 650W	2 to 20
Aurora AUDSP400X 60-400VA	1 to 20
Aurora DSP801 800W	2 to 20
Aurora AUDSP 250W	5 to 10
Aurora AUDSP 400	2 to 20
BE AT091 60-500W	3 to 30
BG 1P01 400W	2 to 20
Crabtree 8250 DS55 250W	5 to 20
Click MD9042 60-400W	1 to 20
Danler DPID 250W	1 to 20
Hamilton 741X40 400W	1 to 20
Hamilton 8413XU 40-300VA	1 to 20
Hamilton Litestat 40-400W	2 to 20
Hamilton L400/2 40-400W	2 to 20
Hamilton Mercury MDP4x600+VFR	1 to 32
Le Grande Synergy 7300	2 to 20
Lutron Grafik Eye QSGRK-4PCE-TWH	1 to 25
Lutron QS Link	1 to 14
MK KU511 WHILV 4-700 LED	1 to 14
MK K1532 40-250W	3 to 20
MK 1501 RD 60-500W	1 to 16
Superswitch 1G2W 250W	2 to 20
Varilight V-PRO ZOJP250-P 100W	1 to 20
Varilight HQ7W 120W	2 to 20
Varilight IJSI 101 100W	4 to 20
Varilight KQP401W 400W	2 to 20
Varilight KQP601W 600W	3 to 20
Varilight VPRO MJP300	2 to 30
Varilight GKP 180 180W	2 to 30
Varilight HQ7 120W	2 to 20
Varilight HQ3W 400W	1 to 20
Varilight HQ1 400W	1 to 20



## LED Genesis GU10

The Genesis GU10 is our newest edition to the GU10 range. This 4.4W GU10 is available as Non-Dimmable and Dimmable in 3 colour temperatures. The Genesis GU10 offers sleek aesthetics and is destined to be one of our best all-purpose GU10's, suitable for multiple applications.

- Energy saving benefits of LED
- Rimless lens for improved aesthetics
- True fit GU10 size
- Suitable for fire rated and IP rated fixtures
- 38° Beam angle
- 15000 Hours



4.4W  $\frac{50}{W}$  Energy Saving 91%

Warm White

Cool White

H 54mm Ø50mm

Code	Lamp Type	CCT	Lm	Cd	Dim	V	Hours
Non Dimmable							
60670	4.4W Genesis GU10 Non-Dim	2700K	350	630	Non Dim	240	15000
60671	4.4W Genesis GU10 Non-Dim	3000K	350	630	Non Dim	240	15000
60672	4.4W Genesis GU10 Non-Dim	4000K	350	630	Non Dim	240	15000
Dimmable							
60673	4.4W Genesis GU10 Dim	2700K	350	630	Dim	240	15000
60674	4.4W Genesis GU10 Dim	3000K	350	630	Dim	240	15000
60675	4.4W Genesis GU10 Dim	4000K	350	630	Dim	240	15000





## LED Halo GU10

The Halo GU10 is our most popular GU10 lamp to date. This 3.2W cost effective GU10 is available as Non-Dimmable and Dimmable in 4 colour temperatures and wattages. This true fit size GU10 combines price fighting qualities with sleek aesthetics to feature as one of our best "all-rounders".

- Energy saving benefits of LED
- Improved efficiency up to 110 Lm/W
- Rimless lens for improved aesthetics
- True fit GU10 size
- Suitable for fire rated and IP rated fixtures
- 38° & 60° beam angle options



3.2W  $\frac{50}{W}$  Energy Saving 93%

Warm White

Cool White

Daylight

H 53mm Ø50mm



Index



F

www.belllighting.co.uk

technical@belllighting.co.uk  
sales@belllighting.co.uk





## LED Halo GU10

Code	Lamp Type	CCT	Lm	Cd	Dim	V	Hours
Non Dimmable							
60600	3.2W LED Halo GU10 - 38°	2700K	350	450	Non Dim	240	20000
60607	3.2W LED Halo GU10 - 38°	3000K	350	450	Non Dim	240	20000
60601	3.2W LED Halo GU10 - 38°	4000K	350	450	Non Dim	240	20000
60602	3.2W LED Halo GU10 - 38°	6500K	350	450	Non Dim	240	20000
60606	3.2W LED Halo GU10 - 60°	2700K	350	250	Non Dim	240	20000
60608	3.2W LED Halo GU10 - 60°	4000K	350	250	Non Dim	240	20000
60609	3.2W LED Halo GU10 - 60°	6500K	350	250	Non Dim	240	20000
60614	3.2W LED Halo GU10 - 38°, 2700K, In Packs of 5, Supplied in 2 Counter Display Units	2700K	350	-	Non Dim	240	-
60615	3.2W LED Halo GU10 - 38°, 4000K, In Packs of 5, Supplied in 2 Counter Display Units	4000K	350	-	Non Dim	240	-
Dimmable							
60603	3.2W LED Halo GU10 Dimmable - 38°	2700K	350	450	Dim	240	20000
60611	3.2W LED Halo GU10 Dimmable - 38°	3000K	350	450	Dim	240	20000
60604	3.2W LED Halo GU10 Dimmable - 38°	4000K	350	450	Dim	240	20000
60605	3.2W LED Halo GU10 Dimmable - 38°	6500K	350	450	Dim	240	20000
60610	3.2W LED Halo GU10 Dimmable - 60°	2700K	350	250	Dim	240	20000
60612	3.2W LED Halo GU10 Dimmable - 60°	4000K	350	250	Dim	240	20000
60613	3.2W LED Halo GU10 Dimmable - 60°	6500K	350	250	Dim	240	20000

Index

<sup>1</sup> Exceeds EU standard of 70 for Lumens Maintenance Ratio  
<sup>2</sup> Exceeds EU standard of RA 80 for Colour Rendering Index  
<sup>3</sup> Subject to terms & conditions (Contact Customer Service)  
 Call Customer Service or see website for maximum loading and dimmer compatibility.



## LED Halo Elite GU10

The Halo Elite GU10 combines the tried and tested technology of the Halo GU10 with a high lumen output. Ideal for illuminating spaces at a higher lux level while not breaking the bank.

- High output GU10
- Energy saving benefits of LED
- Improved efficiency up to 110 Lm/W
- Rimless lens for improved aesthetics
- True fit GU10 size
- Suitable for fire rated and IP rated fixtures



5W  $\frac{75}{W}$  Energy Saving 93%

Warm White

Cool White

Daylight

H 53mm Ø50mm





## LED Halo Elite GU10

Code	Lamp Type	CCT	Lm	Cd	Dim	V	Hours
Non Dimmable							
60616	5W LED Halo Elite GU10 Non Dim - 38°	2700K	550	750	Non Dim	240	25000
60617	5W LED Halo Elite GU10 Non Dim - 38°	3000K	550	750	Non Dim	240	25000
60618	5W LED Halo Elite GU10 Non Dim - 38°	4000K	550	750	Non Dim	240	25000
60619	5W LED Halo Elite GU10 Non Dim - 38°	6500K	550	750	Non Dim	240	25000
60624	5W LED Halo Elite GU10 Non Dim - 60°	2700K	550	400	Non Dim	240	25000
60625	5W LED Halo Elite GU10 Non Dim - 60°	3000K	550	400	Non Dim	240	25000
60626	5W LED Halo Elite GU10 Non Dim - 60°	4000K	550	400	Non Dim	240	25000
60627	5W LED Halo Elite GU10 Non Dim - 60°	6500K	550	400	Non Dim	240	25000
Dimmable							
60620	5W LED Halo Elite GU10 Dimmable - 38°	2700K	550	750	Dim	240	25000
60621	5W LED Halo Elite GU10 Dimmable - 38°	3000K	550	750	Dim	240	25000
60622	5W LED Halo Elite GU10 Dimmable - 38°	4000K	550	750	Dim	240	25000
60623	5W LED Halo Elite GU10 Dimmable - 38°	6500K	550	750	Dim	240	25000
60628	5W LED Halo Elite GU10 Dimmable - 60°	2700K	550	400	Dim	240	25000
60629	5W LED Halo Elite GU10 Dimmable - 60°	3000K	550	400	Dim	240	25000
60630	5W LED Halo Elite GU10 Dimmable - 60°	4000K	550	400	Dim	240	25000
60631	5W LED Halo Elite GU10 Dimmable - 60°	6500K	550	400	Dim	240	25000

<sup>1</sup> Exceeds EU standard of 70 for Lumens Maintenance Ratio  
<sup>2</sup> Exceeds EU standard of RA 80 for Colour Rendering Index  
<sup>3</sup> Subject to terms & conditions (Contact Customer Service)  
 Call Customer Service or see website for maximum loading and dimmer compatibility.

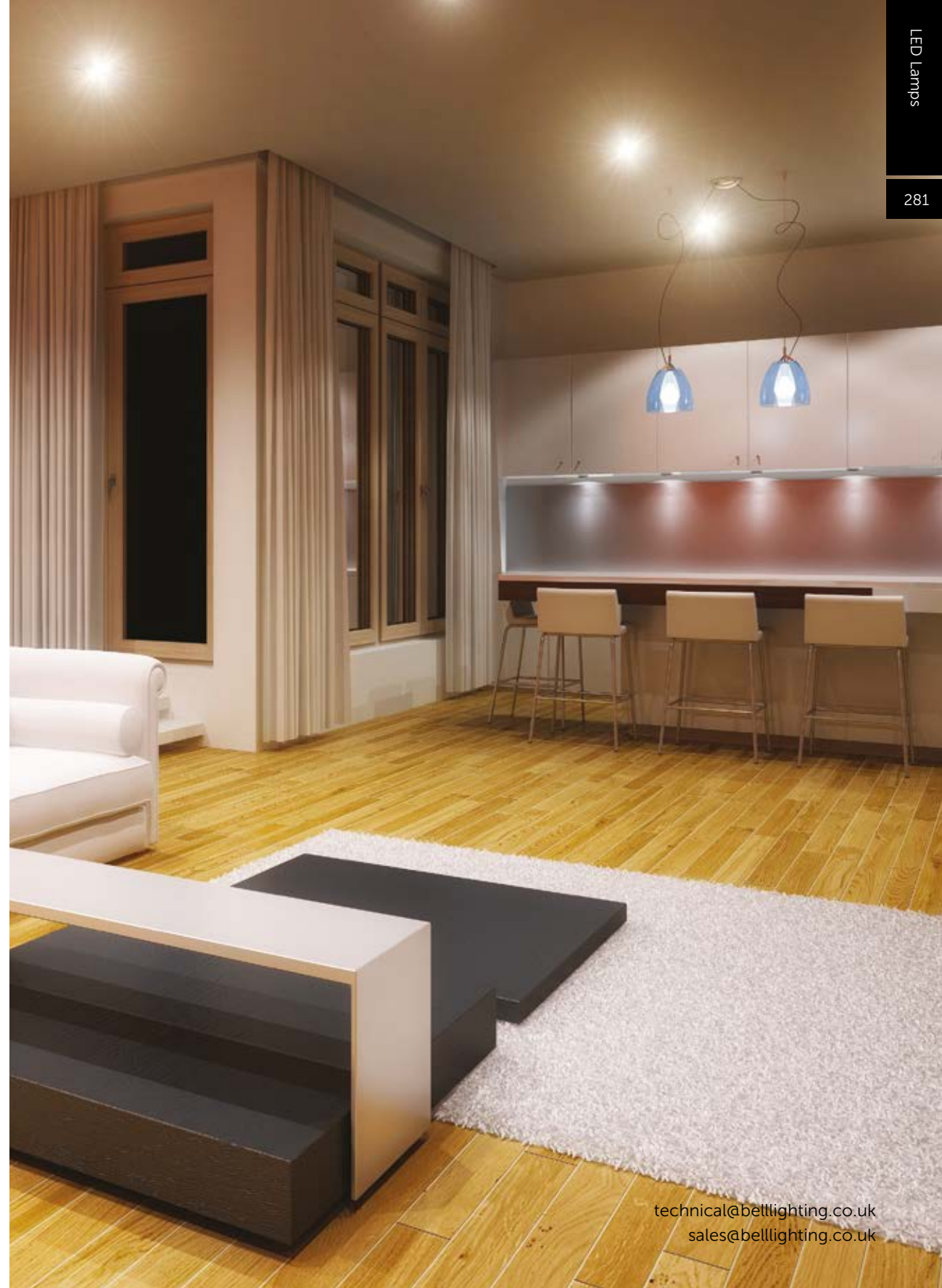





## LED Halo Glass GU10

The Halo Glass combines the retro feel of halogen lamps with the efficiency of LED technology. The high-grade driver within the Halo Glass allows for smooth dimming at minimum and maximum load levels. The precision moulded polycarbonate lens ensures precise beam angle light distribution.

- True fit GU10 size
- Dimmable & Non Dim available
- Suitable for fire rated and IP rated fixtures
- 38° beam angle
- High grade driver designed for smooth dimming at min & max load levels, operating effectively with rotary and digital dimming system (dimmable version)



Warm White  
Cool White  
Daylight  
H 53mm Ø50mm

Code	Lamp Type	CCT	Lm	Cd	Dim	V	Hours
Non Dimmable							
60646	3.1W LED Halo Glass GU10	2700K	350	650	Non Dim	240	20000
60652	3.1W LED Halo Glass GU10	3000K	350	650	Non Dim	240	20000
60647	3.1W LED Halo Glass GU10	4000K	350	650	Non Dim	240	20000
60648	3.1W LED Halo Glass GU10	6500K	350	650	Non Dim	240	20000
Dimmable							
60649	3.1W LED Halo Glass GU10 Dimmable	2700K	350	650	Dim	240	20000
60653	3.1W LED Halo Glass GU10 Dimmable	3000K	350	650	Dim	240	20000
60650	3.1W LED Halo Glass GU10 Dimmable	4000K	350	650	Dim	240	20000
60651	3.1W LED Halo Glass GU10 Dimmable	6500K	350	650	Dim	240	20000





## LED Halo Elite Glass GU10

The Halo Elite Glass combines the retro feel of halogen lamps with the efficiency of LED technology. The high-grade driver within the Halo Elite Glass allows for smooth dimming at minimum and maximum load levels. The precision moulded polycarbonate lens ensures precise beam angle light distribution.

- True fit GU10 size
- Dimmable & Non Dim available
- Suitable for fire rated and IP rated fixtures
- 38° beam angle
- High grade driver designed for smooth dimming at min & max load levels, operating effectively with rotary and digital dimming system (dimmable version)



Warm White  
Cool White  
Daylight  
H 53mm Ø50mm

Code	Lamp Type	CCT	Lm	Cd	Dim	V	Hours
Non Dimmable							
60640	4.2W LED Halo Elite Glass GU10	2700K	470	750	Non Dim	240	25000
60641	4.2W LED Halo Elite Glass GU10	4000K	470	750	Non Dim	240	25000
60642	4.2W LED Halo Elite Glass GU10	6500K	470	750	Non Dim	240	25000
Dimmable							
60643	4.2W LED Halo Elite Glass GU10 Dimmable	2700K	470	750	Dim	240	25000
60644	4.2W LED Halo Elite Glass GU10 Dimmable	4000K	470	750	Dim	240	25000
60645	4.2W LED Halo Elite Glass GU10 Dimmable	6500K	470	750	Dim	240	25000





## LED Dim to Warm GU10

With this BELL Dim to Warm GU10 lamp you can now access 2700K–2200K CCT. With a warm glow dimming effect, light levels dim to warm tones of traditional lamps.

When you reduce the brightness using a dimmer switch, you will see a drop in the colour temperature from 2700K down to a soothing, warm 2200K. Perfect for a more relaxing atmosphere in residential buildings, hotels, restaurants and bars.

Traditional halogen look with the energy saving benefits of LED

- True fit GU10 size
- Emits a warmer light when dimmed
- Creates cosy ambience when dimmed
- Replicates dimming of halogen lamps
- Colour temperature range 2200K-2700K
- 92% Energy Saving
- Part L



3.8W  $\frac{50}{W}$  Energy Saving 92%

Warm White

H 56mm Ø50mm

Code	Lamp Type	CCT	Lm	Cd	Dim	V	Hours
Dimmable							
60634	3.8W LED Halo GU10 Dim to Warm - 38°	2200-2700K	420	600	Dim	240	25000







## LED Long Neck GU10

The Long Neck GU10 is well known for being somewhat of a problem solver within the GU10 market. This ideal replacement for Long Neck CFL GU10's has been specifically designed to fit deep recessed downlight fittings. Available in Warm White & Cool White, this lamp incorporates a wide beam angle for a broad light distribution.

- Ideal Replacement for Long Neck CFL GU10
- Designed to fit deep recessed downlight fittings
- Suitable for fire rated and IP rated fixtures
- 25000 Hours
- Available in Warm White and Cool White
- H 74mm Ø 50mm



4.9W 35W 86%

Warm White

Cool White

H 74mm Ø50mm

Code	Lamp Type	CCT	Lm	Cd	Dim	V	Hours
Non Dimmable							
60632	4.9W Long Neck Non Dim GU10 100°	3000K	450	180	Non Dim	240	25000
60633	4.9W Long Neck Non Dim GU10 100°	4000K	450	180	Non Dim	240	25000

<sup>1</sup> Exceeds EU standard of 70 for Lumens Maintenance Ratio

<sup>2</sup> Exceeds EU standard of RA 80 for Colour Rendering Index

<sup>3</sup> Subject to terms & conditions (Contact Customer Service)

Call Customer Service or see website for maximum loading and dimmer compatibility.







## LV LED Halo MR16

The Halo MR16 provides a low voltage solution combined with sleek aesthetics.

- High output MR16
- Energy saving benefits of LED
- Rimless lens for improved aesthetics
- True fit MR16 size
- Suitable for fire rated and IP rated fixtures



Warm White

Cool White

Daylight

H 52mm Ø50mm

Code	Lamp Type	CCT	Lm	Cd	Dim	V	Hours
Non Dimmable							
60700	4.9W LED Halo MR16 Non Dim 38°	2700K	530	650	Non Dim	12	25000
60701	4.9W LED Halo MR16 Non Dim 38°	4000K	530	650	Non Dim	12	25000
60702	4.9W LED Halo MR16 Non Dim 38°	6500K	530	650	Non Dim	12	25000

12V LED lamps require a BELL line driver or quality branded transformer

<sup>1</sup> Exceeds EU standard of 70 for Lumens Maintenance Ratio

<sup>2</sup> Exceeds EU standard of RA 80 for Colour Rendering Index

<sup>3</sup> Subject to terms & conditions (Contact Customer Service)

Call Customer Service or see website for maximum loading and dimmer compatibility.







## LV LED Halo MR11

The Halo MR11 provides a sleek, contemporary design with the energy saving benefits of LED. This low voltage lamp is an ideal replacement when retrofitting inefficient light sources.

- True fit MR11 size
- 5 year Warranty
- 85% Energy Saving
- Warm White, 3000K
- 24° Beam angle creates a focussed beam of light, that can be used for multiple applications



Warm White  
H 38mm Ø35mm

Code	Lamp Type	CCT	Lm	Cd	Dim	V	Hours
Non Dimmable							
05611	3W LED MR11, Non Dim 24°	3000K	200	600	Non Dim	12	30000

12V LED lamps require a BELL line driver or quality branded transformer

<sup>1</sup> Exceeds EU standard of 70 for Lumens Maintenance Ratio

<sup>2</sup> Exceeds EU standard of RA 80 for Colour Rendering Index

<sup>3</sup> Subject to terms & conditions (Contact Customer Service)

Call Customer Service or see website for maximum loading and dimmer compatibility.





## LED AR111

The AR111 provides clean, crisp lighting, ideal for the retail environment, along with a high Colour Rendering Index (CRI) which ensures products are displayed to their full potential.

Lamps with poor CRI will distort some colours which may mean you end up with a black sock when you wanted blue.

- Dimmable
- Retrofit Size
- 25000 Hours Life
- 60° Beam



Warm White

H 66mm Ø111mm

Code	Lamp Type	CCT	Lm	Dim	V	Hours
Dimmable						
60827	10W LED AR111 Dimmable - GU10, 60°	2700K	950	Dim	240	25000
Mains voltage dimming						

<sup>1</sup> Exceeds EU standard of 70 for Lumens Maintenance Ratio

<sup>2</sup> Exceeds EU standard of RA 80 for Colour Rendering Index

<sup>3</sup> Subject to terms & conditions (Contact Customer Service)

Call Customer Service or see website for maximum loading and dimmer compatibility.

technical@belllighting.co.uk

sales@belllighting.co.uk





## LED PAR Lamps

The BELL LED PAR Lamps are perfect for all retail and display applications. Available in a variety of sizes & wattages to ensure we have a solution for each individual retail space.

- Specially designed to replace existing Halogen Lamps
- Retro fit for halogen
- Perfect for all retail and display applications
- PAR 16/20/25/30/38
- 30000 hours
- Full dimming on rotary and digital dimming systems
- 2700K Warm White colour temperature



Warm White

6W LED PAR 16 H 80mm Ø50mm

8W LED PAR 20 H 90mm Ø60mm

8W LED PAR 25 H 101mm Ø80mm

12W LED PAR 30 H 94mm Ø95mm

14W LED PAR 38 H 134mm Ø122 mm







## LED PAR Lamps

Code	Lamp Type	CCT	Lm	Cd	Dim	V	Hours
Dimmable							
05864	6W LED PAR16 Dimmable - SES	2700K	400	1000	Dim	240	30000
05865	8W LED PAR20 Dimmable - ES	2700K	580	1350	Dim	240	30000
05866	8W LED PAR25 Dimmable - ES	2700K	580	1350	Dim	240	30000
05867	12W LED PAR30 Dimmable - ES	2700K	1000	2000	Dim	240	30000
05868	14W LED PAR38 Dimmable - ES	2700K	1150	2200	Dim	240	30000

<sup>1</sup> Exceeds EU standard of 70 for Lumens Maintenance Ratio

<sup>2</sup> Exceeds EU standard of RA 80 for Colour Rendering Index

<sup>3</sup> Subject to terms & conditions (Contact Customer Service)

Call Customer Service or see website for maximum loading and dimmer compatibility.





## LED External PAR 38 Lamps

The LED External Par 38 Lamp is ideal for all accent lighting applications. Often used on the exterior of premises to give a warm welcoming feel on walkways, paths, entrance, lobbies and gardens.

- New LED PAR38 lamp provides energy efficient accent lighting
- Suitable for outdoor use in a certified IP rated fixture
- Long life of 30,000 hours
- Low maintenance costs
- Sustainable lighting technology



Clear

H 130mm Ø121mm

Code	Lamp Type	CCT	Lm	Dim	V	Hours
Non Dimmable						
05650	15W LED PAR38 External Non Dim - ES, Clear	2700K	1300	Non Dim	240	30000
Suitable for outdoor use in a certified IP rated fixture						

<sup>1</sup> Exceeds EU standard of 70 for Lumens Maintenance Ratio

<sup>2</sup> Exceeds EU standard of RA 80 for Colour Rendering Index

<sup>3</sup> Subject to terms & conditions (Contact Customer Service)

Call Customer Service or see website for maximum loading and dimmer compatibility.





## LED Filament Candle

The LED Filament Range combines LED technology with the elegance of Incandescent Lamps. Creating a welcoming atmosphere with a retro feel, our LED Filament Range offers smooth dimming on rotary and digital dimming systems. The Filament Candle is ideal for all chandeliers and wall lights.

- LED Technology with the elegance of Incandescent Lamps
- Ideal Replacement for Incandescent Lamps
- Creates a welcoming atmosphere with retro feel
- Up to 93% Energy Saving
- Argon gas filled to improve life
- High temperature capping cement
- Smooth dimming on rotary and digital dimming systems
- Full glass envelope



Warm White

Cool White

3.3W BC/ES Candle H 92mm Ø35mm

3.3W SBC/SES Candle H 96mm Ø35mm

1W Chandelier H 86mm Ø22mm

3.3W Bent Tip Candle H 115mm Ø35mm







## LED Filament Candle

Code	Lamp Type	CCT	Lm	Dim	V	Hours
Non Dimmable						
60703	3.3W LED Filament Clear Candle Non Dim - BC	2700K	470	Non Dim	240	15000
60704	3.3W LED Filament Clear Candle Non Dim - SBC	2700K	470	Non Dim	240	15000
60705	3.3W LED Filament Clear Candle Non Dim - ES	2700K	470	Non Dim	240	15000
60706	3.3W LED Filament Clear Candle Non Dim - SES	2700K	470	Non Dim	240	15000
60707	3.3W LED Filament Satin Candle Non Dim - BC	2700K	470	Non Dim	240	15000
60708	3.3W LED Filament Satin Candle Non Dim - SBC	2700K	470	Non Dim	240	15000
60709	3.3W LED Filament Satin Candle Non Dim - ES	2700K	470	Non Dim	240	15000
60710	3.3W LED Filament Satin Candle Non Dim - SES	2700K	470	Non Dim	240	15000
60711	3.3W LED Filament Clear Candle Non Dim - BC	4000K	470	Non Dim	240	15000
60712	3.3W LED Filament Clear Candle Non Dim - SBC	4000K	470	Non Dim	240	15000
60713	3.3W LED Filament Clear Candle Non Dim - ES	4000K	470	Non Dim	240	15000
60714	3.3W LED Filament Clear Candle Non Dim - SES	4000K	470	Non Dim	240	15000
60715	3.3W LED Filament Bent Tip Clear Candle Non Dim - SES	2700K	470	Non Dim	240	15000
60716	3.3W LED Filament Bent Tip Satin Candle Non Dim - SES	2700K	470	Non Dim	240	15000
05028	1W LED Filament Chandelier - Clear Non Dim SES	2700K	100	Non Dim	240	15000
05029	1W LED Filament Chandelier - Clear Non Dim MES	2700K	100	Non Dim	240	15000

<sup>1</sup> Exceeds EU standard of 70 for Lumens Maintenance Ratio

<sup>2</sup> Exceeds EU standard of RA 80 for Colour Rendering Index

<sup>3</sup> Subject to terms & conditions (Contact Customer Service)

Call Customer Service or see website for maximum loading and dimmer compatibility.



## LED Filament Candle

Code	Lamp Type	CCT	Lm	Dim	V	Hours
Dimmable						
60717	3.3W LED Filament Clear Candle Dimmable - BC	2700K	470	Dim	240	15000
60718	3.3W LED Filament Clear Candle Dimmable - SBC	2700K	470	Dim	240	15000
60719	3.3W LED Filament Clear Candle Dimmable - ES	2700K	470	Dim	240	15000
60720	3.3W LED Filament Clear Candle Dimmable - SES	2700K	470	Dim	240	15000
60721	3.3W LED Filament Satin Candle Dimmable - BC	2700K	470	Dim	240	15000
60722	3.3W LED Filament Satin Candle Dimmable - SBC	2700K	470	Dim	240	15000
60723	3.3W LED Filament Satin Candle Dimmable - ES	2700K	470	Dim	240	15000
60724	3.3W LED Filament Satin Candle Dimmable - SES	2700K	470	Dim	240	15000
60725	3.3W LED Filament Clear Candle Dimmable - BC	4000K	470	Dim	240	15000
60726	3.3W LED Filament Clear Candle Dimmable - SBC	4000K	470	Dim	240	15000
60727	3.3W LED Filament Clear Candle Dimmable - ES	4000K	470	Dim	240	15000
60728	3.3W LED Filament Clear Candle Dimmable - SES	4000K	470	Dim	240	15000
60729	3.3W LED Filament Bent Tip Clear Candle Dimmable - SES	2700K	470	Dim	240	15000
60730	3.3W LED Filament Bent Tip Satin Candle Dimmable - SES	2700K	470	Dim	240	15000



#### Talbot Hotel Malton: BELL 4W Filament Candles

Over the life of the lamps, Talbot Hotel could save: £39,204 in energy costs, Energy Saving 90%

- Annual Energy Saving 47,500kWh
- Annual CO<sub>2</sub> Saving 26,700kg
- Annual Maintenance Saving £1000









## LED Filament Round

Code	Lamp Type	CCT	Lm	Dim	V	Hours
Non Dimmable						
60731	3.3W LED Filament Clear Round Non Dim - BC	2700K	470	Non Dim	240	15000
60732	3.3W LED Filament Clear Round Non Dim - ES	2700K	470	Non Dim	240	15000
60733	3.3W LED Filament Clear Round Non Dim - SES	2700K	470	Non Dim	240	15000
60734	3.3W LED Filament Satin Round Non Dim - BC	2700K	470	Non Dim	240	15000
60735	3.3W LED Filament Satin Round Non Dim - ES	2700K	470	Non Dim	240	15000
60736	3.3W LED Filament Satin Round Non Dim - SES	2700K	470	Non Dim	240	15000
60737	3.3W LED Filament Clear Round Non Dim - BC	4000K	470	Non Dim	240	15000
60738	3.3W LED Filament Clear Round Non Dim - ES	4000K	470	Non Dim	240	15000
60739	3.3W LED Filament Clear Round Non Dim - SES	4000K	470	Non Dim	240	15000
Dimmable						
60740	3.3W LED Filament Clear Round Dimmable - BC	2700K	470	Dim	240	15000
60741	3.3W LED Filament Clear Round Dimmable - ES	2700K	470	Dim	240	15000
60742	3.3W LED Filament Clear Round Dimmable - SES	2700K	470	Dim	240	15000
60743	3.3W LED Filament Satin Round Dimmable - BC	2700K	470	Dim	240	15000
60744	3.3W LED Filament Satin Round Dimmable - ES	2700K	470	Dim	240	15000
60745	3.3W LED Filament Satin Round Dimmable - SES	2700K	470	Dim	240	15000
60746	3.3W LED Filament Clear Round Dimmable - BC	4000K	470	Dim	240	15000
60747	3.3W LED Filament Clear Round Dimmable - ES	4000K	470	Dim	240	15000
60748	3.3W LED Filament Clear Round Dimmable - SES	4000K	470	Dim	240	15000

<sup>1</sup> Exceeds EU standard of 70 for Lumens Maintenance Ratio  
<sup>2</sup> Exceeds EU standard of RA 80 for Colour Rendering Index  
<sup>3</sup> Subject to terms & conditions (Contact Customer Service)  
 Call Customer Service or see website for maximum loading and dimmer compatibility.





## Platinum LED Filament Class A GLS/Squirrel Cage

Our Class A Filament Lamps are our most energy efficient lamps to date. Ultra energy saving lighting technology reduces carbon emissions and ensures low energy usage. Available in the ever popular GLS or as a decorative Squirrel Cage, these 50,000 hour lamps last over 3 times longer than standard LED lamps.

- LED Technology with the elegance of Incandescent Lamps
- Ideal Replacement for Incandescent Lamps
- Creates a welcoming atmosphere with retro feel
- 94% Energy Saving
- Argon gas filled to improve life
- High temperature capping cement
- Smooth dimming on rotary and digital dimming systems
- Full glass envelope



GLS  
Clear  
Warm White H 104mm Ø64mm  
Squirrel Cage  
Clear  
Warm White H 140mm Ø64mm

Code	Lamp Type	CCT	Lm	Dim	V	Hours
Dimmable Class A						
60870	3.8W Platinum LED Filament Class A GLS - BC	2700	806	Dim	240	50000
60871	3.8W Platinum LED Filament Class A GLS - ES	2700	806	Dim	240	50000
60872	3.8W Platinum LED Filament Class A Squirrel Cage - ES	2700	806	Dim	240	50000





## LED Filament GLS

The LED Filament Range combines LED technology with the elegance of Incandescent Lamps. Creating a welcoming atmosphere with a retro feel, our LED Filament Range offers smooth dimming on rotary and digital dimming systems. The Filament GLS is an all rounder for decorative applications due to the wide range of wattages we offer.

- LED Technology with the elegance of Incandescent Lamps
- Ideal Replacement for Incandescent Lamps
- Creates a welcoming atmosphere with retro feel
- Up to 92% Energy Saving
- Argon gas filled to improve life
- High temperature capping cement
- Smooth dimming on rotary and digital dimming systems
- Full glass envelope



Clear

Satin

Warm White

Cool White

3.3/5.7W H 108mm Ø60mm

11W H 128mm Ø70mm







## LED Filament GLS

Code	Lamp Type	CCT	Lm	Dim	V	Hours
Non Dimmable						
60749	3.3W LED Filament Clear GLS Non Dim - BC	2700K	470	Non Dim	240	15000
60750	3.3W LED Filament Clear GLS Non Dim - ES	2700K	470	Non Dim	240	15000
60751	5.7W LED Filament Clear GLS Non Dim - BC	2700K	810	Non Dim	240	15000
60752	5.7W LED Filament Clear GLS Non Dim - ES	2700K	810	Non Dim	240	15000
60753	3.3W LED Filament Satin GLS Non Dim - BC	2700K	470	Non Dim	240	15000
60754	3.3W LED Filament Satin GLS Non Dim - ES	2700K	470	Non Dim	240	15000
60755	5.7W LED Filament Satin GLS Non Dim - BC	2700K	810	Non Dim	240	15000
60756	5.7W LED Filament Satin GLS Non Dim - ES	2700K	810	Non Dim	240	15000
60757	3.3W LED Filament Clear GLS Non Dim - BC	4000K	470	Non Dim	240	15000
60758	3.3W LED Filament Clear GLS Non Dim - ES	4000K	470	Non Dim	240	15000
60759	5.7W LED Filament Clear GLS Non Dim - BC	4000K	810	Non Dim	240	15000
60760	5.7W LED Filament Clear GLS Non Dim - ES	4000K	810	Non Dim	240	15000
60823	11W LED Filament Clear GLS Non Dim - BC	2700K	1550	Non Dim	240	15000
60761	11W LED Filament Clear GLS Non Dim - ES	2700K	1550	Non Dim	240	15000
Dimmable						
60762	3.3W LED Filament Clear GLS Dimmable - BC	2700K	470	Dim	240	15000
60763	3.3W LED Filament Clear GLS Dimmable - ES	2700K	470	Dim	240	15000
60764	5.7W LED Filament Clear GLS Dimmable - BC	2700K	810	Dim	240	15000
60765	5.7W LED Filament Clear GLS Dimmable - ES	2700K	810	Dim	240	15000
60766	3.3W LED Filament Satin GLS Dimmable - BC	2700K	470	Dim	240	15000
60767	3.3W LED Filament Satin GLS Dimmable - ES	2700K	470	Dim	240	15000
60768	5.7W LED Filament Satin GLS Dimmable - BC	2700K	810	Dim	240	15000
60769	5.7W LED Filament Satin GLS Dimmable - ES	2700K	810	Dim	240	15000
60770	3.3W LED Filament Clear GLS Dimmable - BC	4000K	470	Dim	240	15000
60771	3.3W LED Filament Clear GLS Dimmable - ES	4000K	470	Dim	240	15000
60772	5.7W LED Filament Clear GLS Dimmable - BC	4000K	810	Dim	240	15000
60773	5.7W LED Filament Clear GLS Dimmable - ES	4000K	810	Dim	240	15000
60824	11W LED Filament Clear GLS Dimmable - BC	2700K	1550	Dim	240	15000
60774	11W LED Filament Clear GLS Dimmable - ES	2700K	1550	Dim	240	15000

Index





## LED Filament Squirrel Cage

The LED Filament Range combines LED technology with the elegance of Incandescent Lamps. Creating a welcoming atmosphere with a retro feel, our LED Filament Range offers smooth dimming on rotary and digital dimming systems. The Filament Squirrel Cage has a contemporary timeless design ideal for bars & restaurants.

- LED Technology with the elegance of Incandescent Lamps
- Ideal Replacement for Incandescent Lamps
- Creates a welcoming atmosphere with retro feel
- 92% Energy Saving
- Argon gas filled to improve life
- High temperature capping cement
- Smooth dimming on rotary and digital dimming systems
- Full glass envelope



Clear

H 126mm Ø58mm

Code	Lamp Type	CCT	Lm	Dim	V	Hours
Non Dimmable						
60775	3.3W LED Filament Squirrel Cage Non Dim - BC	2700K	470	Non Dim	240	15000
60776	3.3W LED Filament Squirrel Cage Non Dim - ES	2700K	470	Non Dim	240	15000
Dimmable						
60777	3.3W LED Filament Squirrel Cage Dimmable - BC	2700K	470	Dim	240	15000
60778	3.3W LED Filament Squirrel Cage Dimmable - ES	2700K	470	Dim	240	15000

<sup>1</sup>Exceeds EU standard of 70 for Lumens Maintenance Ratio

<sup>2</sup>Exceeds EU standard of RA 80 for Colour Rendering Index

<sup>3</sup>Subject to terms & conditions (Contact Customer Service)

Call Customer Service or see website for maximum loading and dimmer compatibility.



## LED Filament Tubular

The LED Filament Range combines LED technology with the elegance of Incandescent Lamps. Creating a welcoming atmosphere with a retro feel, our LED Filament Range offers smooth dimming on rotary and digital dimming systems. The Tubular Filaments provide a distinctive look when illuminated in any bar or restaurant.

- LED Technology with the elegance of Incandescent Lamps
- Creates a welcoming atmosphere with retro feel
- Argon gas filled to improve life



Clear

Warm White

Short H 110mm Ø45mm

Medium H 130mm Ø30mm

Long H 280mm Ø30mm

Code	Lamp Type	CCT	Lm	Dim	V	Hours
Non Dimmable						
60779	3.3W LED Filament Tubular Short Non Dim - BC	2700K	470	Non Dim	240	15000
60780	3.3W LED Filament Tubular Short Non Dim - ES	2700K	470	Non Dim	240	15000
60781	3.3W LED Filament Tubular Med Non Dim - ES	2700K	470	Non Dim	240	15000
60782	5.7W LED Filament Tubular Long Non Dim - ES	2700K	810	Non Dim	240	15000
Dimmable						
60783	3.3W LED Filament Tubular Short Dimmable - BC	2700K	470	Dim	240	15000
60784	3.3W LED Filament Tubular Short Dimmable - ES	2700K	470	Dim	240	15000
60785	3.3W LED Filament Tubular Med Dimmable - ES	2700K	470	Dim	240	15000
60786	5.7W LED Filament Tubular Long Dimmable - ES	2700K	810	Dim	240	15000

<sup>1</sup> Exceeds EU standard of 70 for Lumens Maintenance Ratio

<sup>2</sup> Exceeds EU standard of RA 80 for Colour Rendering Index

<sup>3</sup> Subject to terms & conditions (Contact Customer Service)

Call Customer Service or see website for maximum loading and dimmer compatibility.





## LED Filament Clear Globe

The LED Filament Range combines LED technology with the elegance of Incandescent Lamps. Creating a welcoming atmosphere with a retro feel, our LED Filament Range offers smooth dimming on rotary and digital dimming systems. The Filament Globes are available in two sizes and are an ideal lamp to illuminate any home, hotel, bar or restaurant.

- LED Technology with the elegance of Incandescent Lamps
- Creates a welcoming atmosphere with retro feel
- Argon gas filled to improve life



Clear

Warm White

60787/88/89/90 H 115mm Ø80mm

60791/92/93/94 H 178mm Ø125mm

Code	Lamp Type	CCT	Lm	Dim	V	Hours
<b>Non Dimmable</b>						
60787	3.3W LED Filament Globe Non Dim - BC	2700K	470	Non Dim	240	15000
60788	3.3W LED Filament Globe Non Dim - ES	2700K	470	Non Dim	240	15000
60791	3.3W LED Filament Large Globe Non Dim - BC	2700K	470	Non Dim	240	15000
60792	3.3W LED Filament Large Globe Non Dim - ES	2700K	470	Non Dim	240	15000
<b>Dimmable</b>						
60789	3.3W LED Filament Globe Dimmable - BC	2700K	470	Dim	240	15000
60790	3.3W LED Filament Globe Dimmable - ES	2700K	470	Dim	240	15000
60793	3.3W LED Filament Large Globe Dimmable - BC	2700K	470	Dim	240	15000
60794	3.3W LED Filament Large Globe Dimmable - ES	2700K	470	Dim	240	15000

<sup>1</sup>Exceeds EU standard of 70 for Lumens Maintenance Ratio

<sup>2</sup>Exceeds EU standard of RA 80 for Colour Rendering Index

<sup>3</sup>Subject to terms & conditions (Contact Customer Service)

Call Customer Service or see website for maximum loading and dimmer compatibility.

technical@belllighting.co.uk

sales@belllighting.co.uk





## LED Fairy Lamps

Our new LED Fairy Lamps deliver a unique twist to LED Lighting. Ideal for accent lighting, providing a decorative sparkle. Perfect for events and celebrations both indoor and outside when used with a suitable weatherproof fitting.

- Warm White / Cool White / RGB
- Clear finish
- Decorative Sparkle
- Creates welcoming ambience
- Ideal for events & celebrations
- Add interest to any room
- Perfect for outdoor use (with suitable weatherproof fitting)
- 10000 Hours
- 2.2W / 1.5W
- H 164mm Ø125mm



Clear

H 164mm Ø125mm

Code	Lamp Type	CCT	Lm	Dim	V	Hours
Non Dimmable						
60160	2.2W LED Fairy Lamp - ES	2700K	75	Non Dim	240	10000
60161	2.2W LED Fairy Lamp - ES	4000K	75	Non Dim	240	10000
60162	1.5W LED Fairy Lamp - ES	RGB	20	Non Dim	240	10000

<sup>1</sup>Exceeds EU standard of 70 for Lumens Maintenance Ratio

<sup>2</sup>Exceeds EU standard of RA 80 for Colour Rendering Index

<sup>3</sup>Subject to terms & conditions (Contact Customer Service)

Call Customer Service or see website for maximum loading and dimmer compatibility.





## Aztex High CRI LED Soft Coil Candle/ GLS/Squirrel Cage

High Colour Rendering Index (CRI) lamps provide clean, crisp lighting, ideal for the retail & hospitality environments. A high CRI lamp ensures that brightly coloured products are displayed to their full potential. Lamps with poor CRI will distort some colours which may mean you end up with a green sock when you wanted brown.

Widely used in the hospitality sector and domestically alike, the LED Vintage Lamp combines a traditional look with the energy saving benefits of LED Lighting. The universally used lamps provides a warm white glow ideal when creating mood lighting.

- Special extended filament to replicate traditional vintage amber glow
- Amber Glass Coating for decorative vintage look
- Over 90% energy saving compared to incandescent vintage lamps
- Super low energy consumption



Ultra Warm White

Candle H 95mm Ø35mm

GLS H 115mm Ø60mm

Squirrel Cage H 140mm Ø64mm

Code	Lamp Type	CCT	Lm	Dim	V	Hours
Dimmable						
60027	4W LED Vintage Soft Coil Vertical Filament Candle - SES, Dimmable, Amber	1800K	150	Dim	240	15000
60015	4W LED Vintage Soft Coil Vertical Filament GLS - ES, Dimmable, Amber	1800K	150	Dim	240	15000
60016	4W LED Vintage Soft Coil Vertical Filament GLS - BC, Dimmable, Amber	1800K	150	Dim	240	15000
60017	4W LED Vintage Soft Coil Vertical Filament Squirrel Cage - ES, Dimmable, Amber	1800K	150	Dim	240	15000
60018	4W LED Vintage Soft Coil Vertical Filament Squirrel Cage - BC, Dimmable, Amber	1800K	150	Dim	240	15000

<sup>1</sup> Exceeds EU standard of 70 for Lumens Maintenance Ratio

<sup>2</sup> Exceeds EU standard of RA 80 for Colour Rendering Index

<sup>3</sup> Subject to terms & conditions (Contact Customer Service)

Call Customer Service or see website for maximum loading and dimmer compatibility.

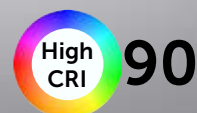





## Aztex High CRI LED Soft Coil Pear Drop/ Large Globe

The Soft Coil Pear Drop and Large Globes are perfect for those wanting to make a statement. With each of the oversized coils giving off an ultra-warm white glow, the large Pear Drops & Globes can be used to give any large space an intimate, welcoming feel.

High Colour Rendering Index (CRI) lamps provide clean, crisp lighting, ideal for the retail & hospitality environments. A high CRI lamp ensures that brightly coloured products are displayed to their full potential. Lamps with poor CRI will distort some colours which may mean you end up with a green sock when you wanted brown.

Widely used in the hospitality sector and domestically alike, the LED Vintage Lamp combines a traditional look with the energy saving benefits of LED Lighting. The universally used lamps provides a warm white glow ideal when creating mood lighting.

- Special extended filament to replicate traditional vintage amber glow
- Amber Glass Coating for decorative vintage look
- Over 90% energy saving compared to incandescent vintage lamps
- Super low energy consumption



Ultra Warm White

Pear Drop H 295mm Ø165mm

Globe H 135mm Ø95mm

Large Globe H 175mm Ø125mm

Giant Globe H 266 Ø200mm

Code	Lamp Type	CCT	Lm	Dim	V	Hours
Dimmable						
60025	4W LED Vintage Soft Coil Vertical Filament Giant Pear Drop Dimmable - ES, Amber	1800K	150	Dim	240	15000
60019	4W LED Vintage Soft Coil Vertical Filament Globe Dimmable - ES, Amber	1800K	150	Dim	240	15000
60021	4W LED Vintage Soft Coil Vertical Filament Large Globe Dimmable - ES, Amber	1800K	150	Dim	240	15000
60023	4W LED Vintage Soft Coil Vertical Filament Giant Globe Dimmable - ES, Amber	1800K	150	Dim	240	15000

<sup>1</sup>Exceeds EU standard of 70 for Lumens Maintenance Ratio

<sup>2</sup>Exceeds EU standard of RA 80 for Colour Rendering Index

<sup>3</sup>Subject to terms & conditions (Contact Customer Service)

Call Customer Service or see website for maximum loading and dimmer compatibility.



Index



## LED Soft Coil Gunmetal Squirrel Cage & Large Globe

The Soft Coil Gunmetal lamp is the most abstract lamp in the Soft Coil product family. This gunmetal finish combined with either a warm white or cool white glow creates two totally different ambiances depending on the what type of mood lighting is required for the application.

- Modern twist on a classic lamp
- Ideal replacement for Incandescent Lamps
- Creates a welcoming atmosphere with retro feel
- Smooth dimming on rotary and digital dimming systems
- 1800K & 4000K colour temperatures available
- Gunmetal Glass Coating for decorative modern look
- 90% Energy Saving compared to Incandescent Vintage Lamps
- Super low energy consumption



Ultra Warm White

Cool White

Squirrel Cage H 140mm Ø64mm

Large Globe H 175mm Ø125mm

Code	Lamp Type	CCT	Lm	Dim	V	Hours
Dimmable						
60028	4W LED Vintage Soft Coil Squirrel Cage Dimmable - ES, Gunmetal	1800K	150	Dim	240	15000
60030	4W LED Vintage Soft Coil Squirrel Cage Dimmable - ES, Gunmetal	4000K	150	Dim	240	15000
60029	4W LED Vintage Soft Coil 125mm Globe Dimmable - ES, Gunmetal	1800K	150	Dim	240	15000
60031	4W LED Vintage Soft Coil 125mm Globe Dimmable - ES, Gunmetal	4000K	150	Dim	240	15000

<sup>1</sup>Exceeds EU standard of 70 for Lumens Maintenance Ratio

<sup>2</sup>Exceeds EU standard of RA 80 for Colour Rendering Index

<sup>3</sup>Subject to terms & conditions (Contact Customer Service)

Call Customer Service or see website for maximum loading and dimmer compatibility.









## LED Vintage Globe

The LED Vintage Lamp has become one of the most recognisable lamp types on the market. Widely used in the hospitality sector and domestically alike, the LED Vintage Lamp combines a traditional look with the energy saving benefits of LED Lighting. With 2 sizes available, the Vintage Globes can be used in a variety of applications, whether that be a cosy lounge or large bar & restaurant.

- Dimmable and Non-Dimmable available
- Special extended filament to replicate traditional vintage amber glow
- Amber Glass Coating For Decorative Vintage Look
- Over 92% energy saving compared to Incandescent Vintage Lamps
- Super low energy consumption



Ultra Warm White

Globe H 115mm Ø80mm

Large Globe H 178mm Ø125mm

Code	Lamp Type	CCT	Lm	Dim	V	Hours
Non Dimmable						
60799	3.3W LED Vintage Globe Non Dim - BC	2200K	365	Non Dim	240	15000
60800	3.3W LED Vintage Globe Non Dim - ES	2200K	365	Non Dim	240	15000
60801	3.3W LED Vintage Large Globe Non Dim - BC	2200K	365	Non Dim	240	15000
60802	3.3W LED Vintage Large Globe Non Dim - ES	2200K	365	Non Dim	240	15000
Dimmable						
60803	3.3W LED Vintage Globe Dimmable - BC	2200K	365	Dim	240	15000
60804	3.3W LED Vintage Globe Dimmable - ES	2200K	365	Dim	240	15000
60805	3.3W LED Vintage Large Globe Dimmable - BC	2200K	365	Dim	240	15000
60806	3.3W LED Vintage Large Globe Dimmable - ES	2200K	365	Dim	240	15000

<sup>1</sup>Exceeds EU standard of 70 for Lumens Maintenance Ratio

<sup>2</sup>Exceeds EU standard of RA 80 for Colour Rendering Index

<sup>3</sup>Subject to terms & conditions (Contact Customer Service)

Call Customer Service or see website for maximum loading and dimmer compatibility.

technical@belllighting.co.uk

sales@belllighting.co.uk



## LED Vintage Globe

The LED Vintage Lamp has become one of the most recognisable lamp types on the market. Widely used in the hospitality sector and domestically alike, the LED Vintage Lamp combines a traditional look with the energy saving benefits of LED Lighting. With 2 sizes available, the Vintage Globes can be used in a variety of applications, whether that be a cosy lounge or large bar & restaurant.

- Dimmable and Non-Dimmable available
- Special extended filament to replicate traditional vintage amber glow
- Amber Glass Coating For Decorative Vintage Look
- Over 92% energy saving compared to Incandescent Vintage Lamps
- Super low energy consumption



Ultra Warm White

Globe H 115mm Ø80mm

Large Globe H 178mm Ø125mm

Code	Lamp Type	CCT	Lm	Dim	V	Hours
Non Dimmable						
60799	3.3W LED Vintage Globe Non Dim - BC	2200K	365	Non Dim	240	15000
60800	3.3W LED Vintage Globe Non Dim - ES	2200K	365	Non Dim	240	15000
60801	3.3W LED Vintage Large Globe Non Dim - BC	2200K	365	Non Dim	240	15000
60802	3.3W LED Vintage Large Globe Non Dim - ES	2200K	365	Non Dim	240	15000
Dimmable						
60803	3.3W LED Vintage Globe Dimmable - BC	2200K	365	Dim	240	15000
60804	3.3W LED Vintage Globe Dimmable - ES	2200K	365	Dim	240	15000
60805	3.3W LED Vintage Large Globe Dimmable - BC	2200K	365	Dim	240	15000
60806	3.3W LED Vintage Large Globe Dimmable - ES	2200K	365	Dim	240	15000

<sup>1</sup>Exceeds EU standard of 70 for Lumens Maintenance Ratio

<sup>2</sup>Exceeds EU standard of RA 80 for Colour Rendering Index

<sup>3</sup>Subject to terms & conditions (Contact Customer Service)

Call Customer Service or see website for maximum loading and dimmer compatibility.

technical@belllighting.co.uk

sales@belllighting.co.uk



## LED Vintage Globe

The LED Vintage Lamp has become one of the most recognisable lamp types on the market. Widely used in the hospitality sector and domestically alike, the LED Vintage Lamp combines a traditional look with the energy saving benefits of LED Lighting. With 2 sizes available, the Vintage Globes can be used in a variety of applications, whether that be a cosy lounge or large bar & restaurant.

- Dimmable and Non-Dimmable available
- Special extended filament to replicate traditional vintage amber glow
- Amber Glass Coating For Decorative Vintage Look
- Over 92% energy saving compared to Incandescent Vintage Lamps
- Super low energy consumption



Ultra Warm White

Globe H 115mm Ø80mm

Large Globe H 178mm Ø125mm

Code	Lamp Type	CCT	Lm	Dim	V	Hours
Non Dimmable						
60799	3.3W LED Vintage Globe Non Dim - BC	2200K	365	Non Dim	240	15000
60800	3.3W LED Vintage Globe Non Dim - ES	2200K	365	Non Dim	240	15000
60801	3.3W LED Vintage Large Globe Non Dim - BC	2200K	365	Non Dim	240	15000
60802	3.3W LED Vintage Large Globe Non Dim - ES	2200K	365	Non Dim	240	15000
Dimmable						
60803	3.3W LED Vintage Globe Dimmable - BC	2200K	365	Dim	240	15000
60804	3.3W LED Vintage Globe Dimmable - ES	2200K	365	Dim	240	15000
60805	3.3W LED Vintage Large Globe Dimmable - BC	2200K	365	Dim	240	15000
60806	3.3W LED Vintage Large Globe Dimmable - ES	2200K	365	Dim	240	15000

<sup>1</sup>Exceeds EU standard of 70 for Lumens Maintenance Ratio

<sup>2</sup>Exceeds EU standard of RA 80 for Colour Rendering Index

<sup>3</sup>Subject to terms & conditions (Contact Customer Service)

Call Customer Service or see website for maximum loading and dimmer compatibility.

technical@belllighting.co.uk

sales@belllighting.co.uk



## LED Vintage Candle

The LED Vintage Lamp has become one of the most recognisable lamp types on the market. Widely used in both the hospitality & domestic sectors, the LED Vintage Lamp combines a traditional look with the energy saving benefits of LED Lighting. The Vintage Candle is an ideal replacement for inefficient light sources in wall lights and chandeliers.

- Dimmable and Non-Dimmable available
- Special extended filament to replicate traditional vintage amber glow
- Amber Glass Coating For Decorative Vintage Look
- Over 90% energy saving compared to incandescent vintage lamps
- Super low energy consumption



Ultra Warm White

BC & ES H 92mm Ø35mm

SBC & SES H 96mm Ø35mm

Code	Lamp Type	CCT	Lm	Dim	V	Hours
Non Dimmable						
60807	3.3W LED Vintage Candle Non Dim - BC	2200K	365	Non Dim	240	15000
60808	3.3W LED Vintage Candle Non Dim - SBC	2200K	365	Non Dim	240	15000
60809	3.3W LED Vintage Candle Non Dim - SES	2200K	365	Non Dim	240	15000
60810	3.3W LED Vintage Candle Non Dim - ES	2200K	365	Non Dim	240	15000
Dimmable						
60811	3.3W LED Vintage Candle Dimmable - BC	2200K	365	Dim	240	15000
60812	3.3W LED Vintage Candle Dimmable - SBC	2200K	365	Dim	240	15000
60813	3.3W LED Vintage Candle Dimmable - SES	2200K	365	Dim	240	15000
60814	3.3W LED Vintage Candle Dimmable - ES	2200K	365	Dim	240	15000

<sup>1</sup>Exceeds EU standard of 70 for Lumens Maintenance Ratio

<sup>2</sup>Exceeds EU standard of RA 80 for Colour Rendering Index

<sup>3</sup>Subject to terms & conditions (Contact Customer Service)

Call Customer Service or see website for maximum loading and dimmer compatibility.





## LED Vintage Tubular

The LED Vintage Lamp has become one of the most recognisable lamp types on the market. Widely used in the hospitality sector and domestically alike, the LED Vintage Lamp combines a traditional look with the energy saving benefits of LED Lighting. The Vintage Tubular's can provide a distinctive look when illuminated in any bar or restaurant.

- Dimmable and Non-Dimmable available
- Special extended filament to replicate traditional vintage amber glow
- Amber Glass Coating For Decorative Vintage Look
- Over 92% energy saving compared to Incandescent Vintage Lamps
- Super low energy consumption



Ultra Warm White

Short H 110mm Ø45mm

Medium H 130mm Ø30mm

Long H 280mm Ø30mm

Code	Lamp Type	CCT	Lm	Dim	V	Hours
Non Dimmable						
60815	3.3W LED Vintage Tubular Short Non Dim - BC	2200K	365	Non Dim	240	15000
60816	3.3W LED Vintage Tubular Short Non Dim - ES	2200K	365	Non Dim	240	15000
60817	3.3W LED Vintage Tubular Med Non Dim - ES	2200K	365	Non Dim	240	15000
60818	5.7W LED Vintage Tubular Long Non Dim - ES	2200K	640	Non Dim	240	15000
Dimmable						
60819	3.3W LED Vintage Tubular Short Dimmable - BC	2200K	365	Dim	240	15000
60820	3.3W LED Vintage Tubular Short Dimmable - ES	2200K	365	Dim	240	15000
60821	3.3W LED Vintage Tubular Med Dimmable - ES	2200K	365	Dim	240	15000
60822	5.7W LED Vintage Tubular Long Dimmable - ES	2200K	640	Dim	240	15000

<sup>1</sup>Exceeds EU standard of 70 for Lumens Maintenance Ratio

<sup>2</sup>Exceeds EU standard of RA 80 for Colour Rendering Index

<sup>3</sup>Subject to terms & conditions (Contact Customer Service)

Call Customer Service or see website for maximum loading and dimmer compatibility.

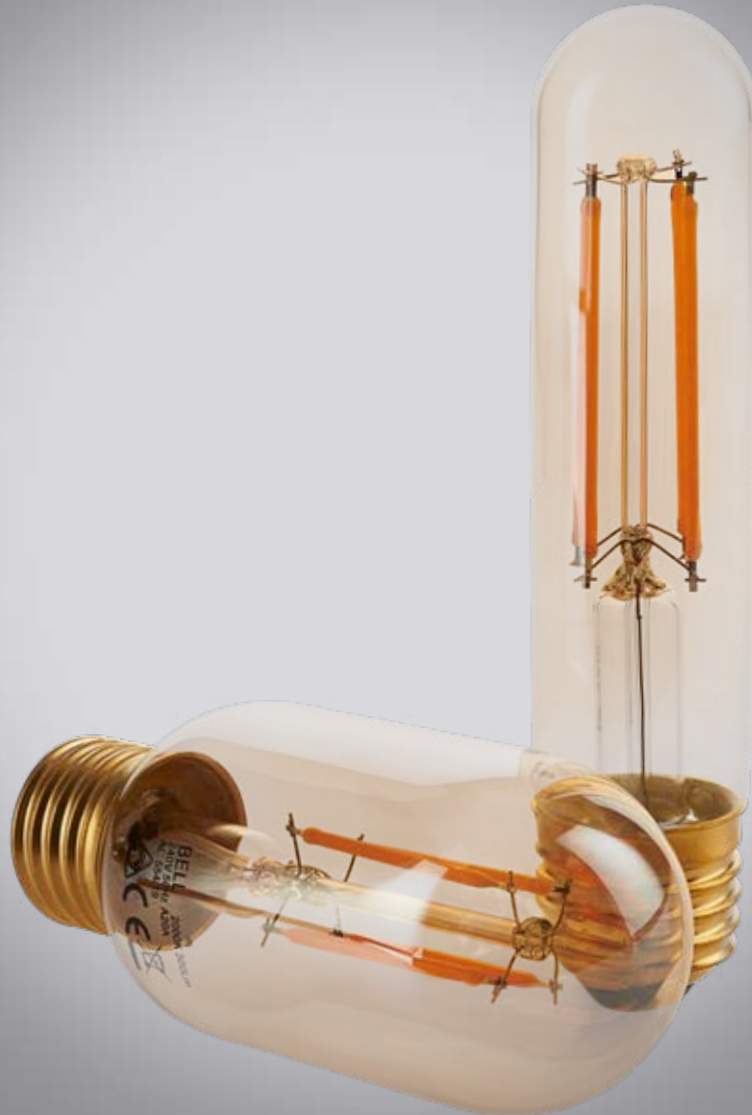





#### Country House Hotel: BELL 4W Vintage Lamps

Over the life of the lamps, the hotel could save: £1,944 in energy costs, Energy Saving 90%

- Annual Energy Saving 4,717kWh
- Annual CO2 Saving 2,642kg
- Annual Maintenance Saving £300



## Aztex LED High CRI Vintage Candle, GLS & Squirrel Cage

High Colour Rendering Index (CRI) lamps provide clean, crisp lighting, ideal for the retail & hospitality environments. A high CRI lamp ensures that brightly coloured products are displayed to their full potential. Lamps with poor CRI will distort some colours which may mean you end up with a green sock when you wanted brown.

Widely used in the hospitality sector and domestically alike, the LED Vintage Lamp combines a traditional look with the energy saving benefits of LED Lighting. The universally used lamps provides a warm white glow ideal when creating mood lighting.

- Special extended filament to replicate traditional vintage amber glow
- Amber Glass Coating for decorative vintage look
- Over 90% energy saving compared to incandescent vintage lamps
- Super low energy consumption



Ultra Warm White

Candle H 96mm Ø35mm

GLS H H 108mm Ø60mm

Squirrel Cage H 126mm Ø58mm

Code	Lamp Type	CCT	Lm	Dim	V	Hours
Dimmable						
60210	4W LED CRI90 Filament Candle - SES, Clear	2200	320	Dim	240	15000
60211	4W LED CRI90 Filament Candle - BC, Clear	2200	320	Dim	240	15000
60212	6W LED CRI90 Filament GLS - ES, Clear	2200	560	Dim	240	15000
60213	6W LED CRI90 Filament GLS - BC, Clear	2200	560	Dim	240	15000
60214	6W LED CRI90 Filament Squirrel Cage ES, Clear	2200	560	Dim	220-240	15000
60216	6W LED CRI90 Vintage Squirrel Cage ES, Amber	2200	560	Dim	220-240	15000

Colour Rendering Index (CRI) measures the ability of a light source to accurately reproduce the colours of the object it illuminates. Colour Rendering Index is a score with a maximum of 100, CRI values that are 90 and above are considered excellent.

<sup>1</sup>Exceeds EU standard of 70 for Lumens Maintenance Ratio

<sup>2</sup>Exceeds EU standard of RA 80 for Colour Rendering Index

<sup>3</sup>Subject to terms & conditions (Contact Customer Service)

Call Customer Service or see website for maximum loading and dimmer compatibility.





## Aztex LED High CRI Vintage Globes

High Colour Rendering Index (CRI) lamps provide clean, crisp lighting, ideal for the retail & hospitality environments. A high CRI lamp ensures that brightly coloured products are displayed to their full potential. Lamps with poor CRI will distort some colours which may mean you end up with a green sock when you wanted brown.

Widely used in the hospitality sector and domestically alike, the LED Vintage Lamp combines a traditional look with the energy saving benefits of LED Lighting. The universally used lamps provides a warm white glow ideal when creating mood lighting.

- Special extended filament to replicate traditional vintage amber glow
- Amber Glass Coating for decorative vintage look
- Over 90% energy saving compared to incandescent vintage lamps
- Super low energy consumption



Ultra Warm White  
H 118mm Ø80mm

Code	Lamp Type	CCT	Lm	Dim	V	Hours
Dimmable						
60215	6W LED CRI90 Filament 80mm Globe ES, Clear	2200	560	Dim	220-240	15000
60217	6W LED CRI90 Vintage 80mm Globe ES, Amber	2200	560	Dim	220-240	15000

Colour Rendering Index (CRI) measures the ability of a light source to accurately reproduce the colours of the object it illuminates. Colour Rendering Index is a score with a maximum of 100, CRI values that are 90 and above are considered excellent.

<sup>1</sup>Exceeds EU standard of 70 for Lumens Maintenance Ratio

<sup>2</sup>Exceeds EU standard of RA 80 for Colour Rendering Index

<sup>3</sup>Subject to terms & conditions (Contact Customer Service)

Call Customer Service or see website for maximum loading and dimmer compatibility.







## Aztex LED High CRI G9 & Pygmy

High Colour Rendering Index (CRI) lamps provide clean, crisp lighting, ideal for the retail & hospitality environments. A high CRI lamp ensures that brightly coloured products are displayed to their full potential. Lamps with poor CRI will distort some colours which may mean you end up with a green sock when you wanted brown.

- Special extended filament to replicate traditional vintage amber glow
- Up to 92% energy saving compared to incandescent vintage lamps
- Super low energy consumption



Ultra Warm White

G9 H 56mm W 15mm D 10mm

Pygmy H 60mm Ø28mm

Code	Lamp Type	CCT	Lm	Dim	V	Hours
Dimmable						
60219	2W LED CRI90 Flat G9 Capsule	2200	210	Dim	220-240	20000
60221	2W LED CRI90 Filament Pygmy - BC, Clear	2200	130	Dim	220-240	15000
60222	2W LED CRI90 Filament Pygmy - SBC, Clear	2200	130	Dim	220-240	15000
60223	2W LED CRI90 Filament Pygmy - SES, Clear	2200	130	Dim	220-240	15000

Colour Rendering Index (CRI) measures the ability of a light source to accurately reproduce the colours of the object it illuminates. Colour Rendering Index is a score with a maximum of 100, CRI values that are 90 and above are considered excellent.

<sup>1</sup>Exceeds EU standard of 70 for Lumens Maintenance Ratio

<sup>2</sup>Exceeds EU standard of RA 80 for Colour Rendering Index

<sup>3</sup>Subject to terms & conditions (Contact Customer Service)

Call Customer Service or see website for maximum loading and dimmer compatibility.

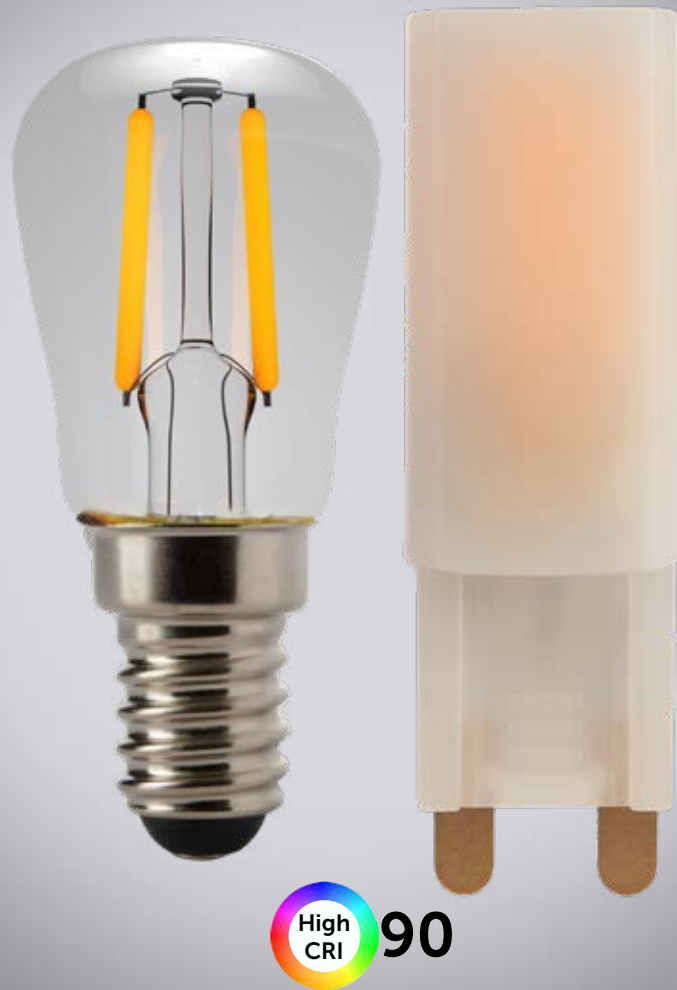

High CRI 90

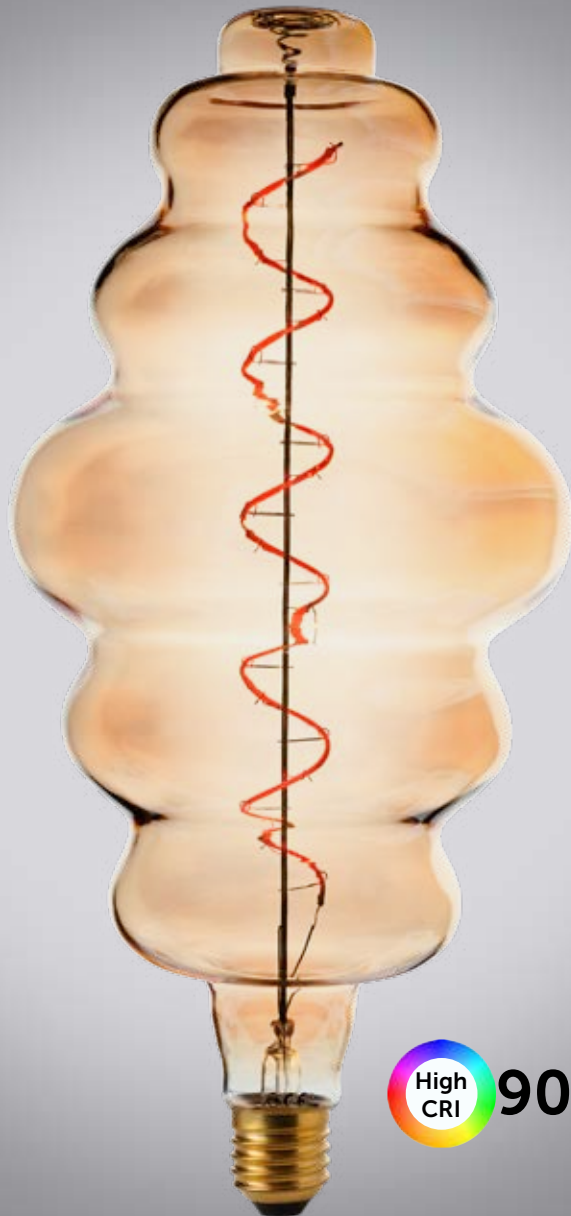

## Aztex LED High CRI Vintage Tower Bubble

High Colour Rendering Index (CRI) lamps provide clean, crisp lighting, ideal for the retail & hospitality environments. A high CRI lamp ensures that brightly coloured products are displayed to their full potential, lamps with poor CRI will distort some colours.

Perfect for the hotel and hospitality environments, creates a welcoming, warm ambience. Offering your staff and customers optimum lighting conditions while reducing energy costs

- Special extended filament to replicate traditional vintage amber glow
- Amber Glass Coating for decorative vintage look
- Over 90% energy saving compared to incandescent vintage lamps
- Super low energy consumption



Ultra Warm White  
H 380mm Ø180mm

Code	Lamp Type	CCT	Lm	Dim	V	Hours
Dimmable						
60218	4W LED CRI90 Vintage Soft Coil Tower Bubble - ES, Amber	1800	100	Dim	220-240	15000

Colour Rendering Index (CRI) measures the ability of a light source to accurately reproduce the colours of the object it illuminates. Colour Rendering Index is a score with a maximum of 100, CRI values that are 90 and above are considered excellent.

<sup>1</sup>Exceeds EU standard of 70 for Lumens Maintenance Ratio

<sup>2</sup>Exceeds EU standard of RA 80 for Colour Rendering Index

<sup>3</sup>Subject to terms & conditions (Contact Customer Service)

Call Customer Service or see website for maximum loading and dimmer compatibility.



## Aztex LED High CRI Vintage Bubble

High Colour Rendering Index (CRI) lamps provide clean, crisp lighting, ideal for the retail & hospitality environments. A high CRI lamp ensures that brightly coloured products are displayed to their full potential, lamps with poor CRI will distort some colours.

Perfect for the hotel and hospitality environments, creates a welcoming, warm ambience. Offering your staff and customers optimum lighting conditions while reducing energy costs

- Special extended filament to replicate traditional vintage amber glow
- Amber Glass Coating for decorative vintage look
- Over 90% energy saving compared to incandescent vintage lamps
- Super low energy consumption



Ultra Warm White  
H 280mm Ø168mm

Code	Lamp Type	CCT	Lm	Dim	V	Hours
Dimmable						
60220	4W LED CRI90 Vintage Soft Coil Bubble ES, Amber	1800	100	Dim	220-240	15000

Colour Rendering Index (CRI) measures the ability of a light source to accurately reproduce the colours of the object it illuminates. Colour Rendering Index is a score with a maximum of 100, CRI values that are 90 and above are considered excellent.

<sup>1</sup>Exceeds EU standard of 70 for Lumens Maintenance Ratio

<sup>2</sup>Exceeds EU standard of RA 80 for Colour Rendering Index

<sup>3</sup>Subject to terms & conditions (Contact Customer Service)

Call Customer Service or see website for maximum loading and dimmer compatibility.

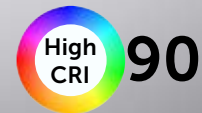





## Aztex LED High CRI Double Ended Strip

High Colour Rendering Index (CRI) lamps provide clean, crisp lighting, ideal for the retail & hospitality environments. A high CRI lamp ensures that brightly coloured products are displayed to their full potential, lamps with poor CRI will distort some colours.

Perfect for the hotel and hospitality environments, creates a welcoming, warm ambience. Offering your staff and customers optimum lighting conditions while reducing energy costs

- Special extended filament to replicate traditional vintage amber glow
- Amber Glass Coating for decorative vintage look
- Over 90% energy saving compared to incandescent vintage lamps
- Super low energy consumption



Ultra Warm White  
H 284mm Ø25mm

Code	Lamp Type	CCT	Lm	Dim	V	Hours
Non Dimmable						
60224	5W LED CRI90 Double Ended Strip Lamp S15, Clear	2200	340	Non Dim	240	15000
Dimmable						
60225	5W LED CRI90 Double Ended Strip Lamp S15, Clear	2200	340	Dim	240	15000

Colour Rendering Index (CRI) measures the ability of a light source to accurately reproduce the colours of the object it illuminates. Colour Rendering Index is a score with a maximum of 100, CRI values that are 90 and above are considered excellent.

<sup>1</sup>Exceeds EU standard of 70 for Lumens Maintenance Ratio

<sup>2</sup>Exceeds EU standard of RA 80 for Colour Rendering Index

<sup>3</sup>Subject to terms & conditions (Contact Customer Service)

Call Customer Service or see website for maximum loading and dimmer compatibility.





## LED Candle

The most cost-effective way of upgrading inefficient lighting. The foundation of LED Lighting (the SMD Candle, Round & GLS) are lamps that the market has become heavily reliant on over the past 10 years. Our LED Candles are available in both 2.1W & 3.9W, Clear & Opal, with a Warm or Cool White light output.

- Direct replacement for Standard Candle
- Retrofit size
- Opal / Clear with crystal lens for multi-directional light and sparkle
- Non Dim / Dimmable with special components for use with UK digital and rotary dimming systems



Clear

Opal

Warm White

Cool White

2.1W Candle H 100mm Ø35mm

3.9W Candle H 100mm Ø35mm





## LED Candle Non Dimmable

Code	Lamp Type	CCT	Lm	Dim	V	Hours
Non Dimmable						
60500	2.1W LED Candle Opal Non Dim - BC	2700K	250	Non Dim	240	25000
60501	2.1W LED Candle Opal Non Dim - SBC	2700K	250	Non Dim	240	25000
60502	2.1W LED Candle Opal Non Dim - SES	2700K	250	Non Dim	240	25000
60503	2.1W LED Candle Opal Non Dim - ES	2700K	250	Non Dim	240	25000
60504	2.1W LED Candle Clear Non Dim - BC	2700K	250	Non Dim	240	25000
60505	2.1W LED Candle Clear Non Dim - SBC	2700K	250	Non Dim	240	25000
60506	2.1W LED Candle Clear Non Dim - SES	2700K	250	Non Dim	240	25000
60507	2.1W LED Candle Clear Non Dim - ES	2700K	250	Non Dim	240	25000
60508	3.9W LED Candle Opal Non Dim - BC	2700K	470	Non Dim	240	25000
60509	3.9W LED Candle Opal Non Dim - SBC	2700K	470	Non Dim	240	25000
60511	3.9W LED Candle Opal Non Dim - ES	2700K	470	Non Dim	240	25000
60510	3.9W LED Candle Opal Non Dim - SES	2700K	470	Non Dim	240	25000
60562	3.9W LED Candle Clear Non Dim - BC	2700K	470	Non Dim	240	25000
60563	3.9W LED Candle Clear Non Dim - SBC	2700K	470	Non Dim	240	25000
60565	3.9W LED Candle Clear Non Dim - ES	2700K	470	Non Dim	240	25000
60564	3.9W LED Candle Clear Non Dim - SES	2700K	470	Non Dim	240	25000

Index

<sup>1</sup> Exceeds EU standard of 70 for Lumens Maintenance Ratio

<sup>2</sup> Exceeds EU standard of RA 80 for Colour Rendering Index

<sup>3</sup> Subject to terms & conditions (Contact Customer Service)

Call Customer Service or see website for maximum loading and dimmer compatibility.



## LED Candle Dimmable

Code	Lamp Type	CCT	Lm	Dim	V	Hours
Dimmable						
60512	2.1W LED Dimmable Candle Opal - BC	2700K	250	Dim	240	25000
60513	2.1W LED Dimmable Candle Opal - SBC	2700K	250	Dim	240	25000
60514	2.1W LED Dimmable Candle Opal - SES	2700K	250	Dim	240	25000
60515	2.1W LED Dimmable Candle Opal - ES	2700K	250	Dim	240	25000
60566	2.1W LED Dimmable Candle Clear - BC	2700K	250	Dim	240	25000
60567	2.1W LED Dimmable Candle Clear - SBC	2700K	250	Dim	240	25000
60568	2.1W LED Dimmable Candle Clear - SES	2700K	250	Dim	240	25000
60569	2.1W LED Dimmable Candle Clear - ES	2700K	250	Dim	240	25000
60570	2.1W LED Dimmable Candle Clear - BC	4000K	250	Dim	240	25000
60571	2.1W LED Dimmable Candle Clear - SBC	4000K	250	Dim	240	25000
60572	2.1W LED Dimmable Candle Clear - SES	4000K	250	Dim	240	25000
60573	2.1W LED Dimmable Candle Clear - ES	4000K	250	Dim	240	25000
60516	3.9W LED Dimmable Candle Opal - BC	2700K	470	Dim	240	25000
60517	3.9W LED Dimmable Candle Opal - SBC	2700K	470	Dim	240	25000
60519	3.9W LED Dimmable Candle Opal - ES	2700K	470	Dim	240	25000
60518	3.9W LED Dimmable Candle Opal - SES	2700K	470	Dim	240	25000
60574	3.9W LED Dimmable Candle Clear - BC	2700K	470	Dim	240	25000
60575	3.9W LED Dimmable Candle Clear - SBC	2700K	470	Dim	240	25000
60577	3.9W LED Dimmable Candle Clear - ES	2700K	470	Dim	240	25000
60576	3.9W LED Dimmable Candle Clear - SES	2700K	470	Dim	240	25000



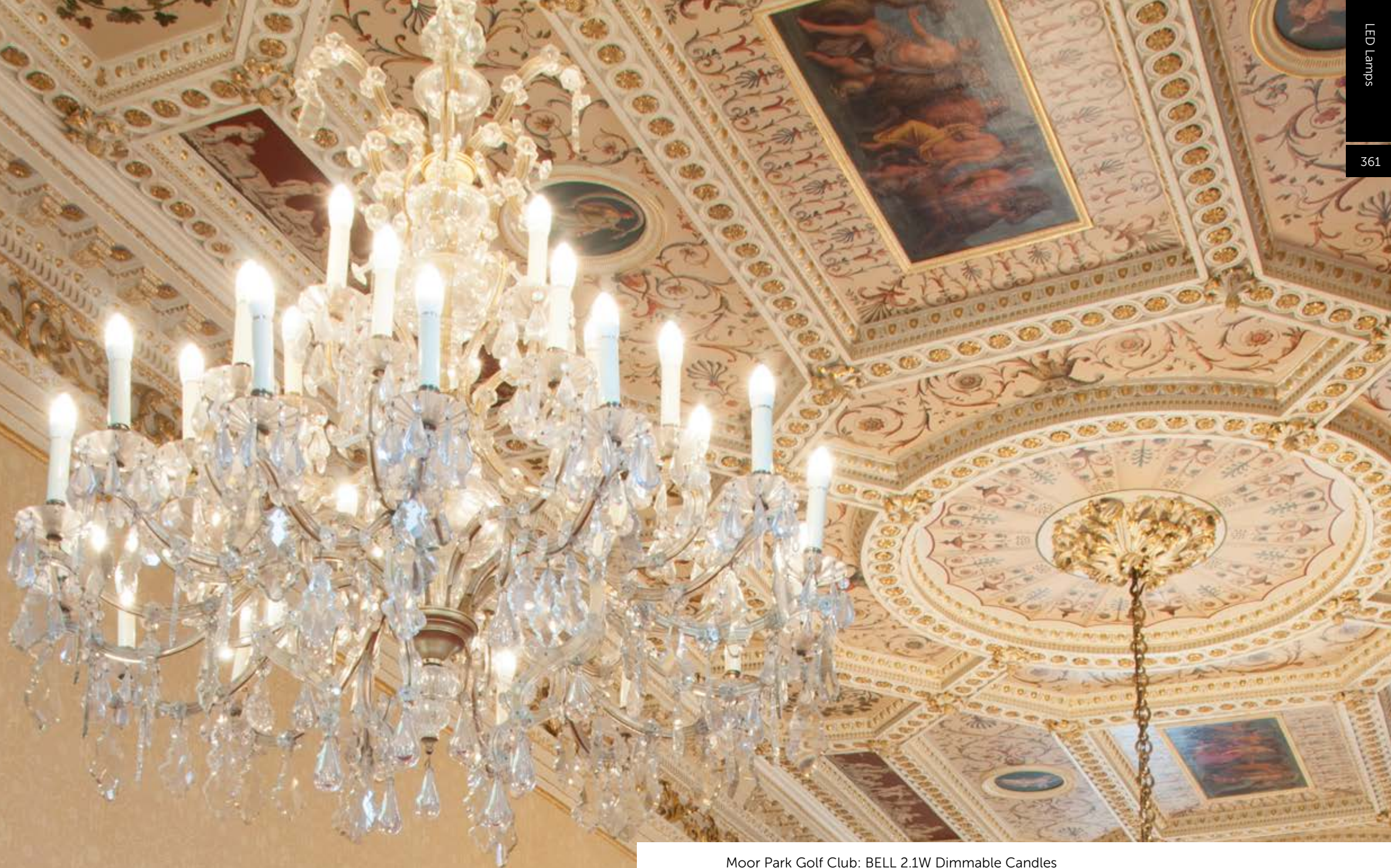

#### Moor Park Golf Club: BELL 2.1W Dimmable Candles

Over the life of the lamps, Moor Park Golf Club could save: £30,462 in energy costs, Energy Saving 93%

- Annual Energy Saving 16,307kWh
- Annual CO2 Saving 9,132kg
- Annual Maintenance Saving £1000





## LED Round

The most cost-effective way of upgrading inefficient lighting. The foundation of LED Lighting (the SMD Candle, Round & GLS) are lamps that the market has become heavily reliant on over the past 10 years. Our LED Rounds are available in 2.1W with the choice of Clear & Opal finishes

- Direct replacement for Standard Round
- Retrofit size
- Opal / Clear
- Non Dimmable & Dimmable



Warm White

Cool White

Opal

Clear

Opal Non Dimmable

BC/B22 H 71mm Ø45mm

ES/E27 H 78mm Ø45mm

SES/E14 H 78mm Ø45mm

Clear Non Dimmable

BC H 70mm Ø45mm

ES H 78mm Ø45mm

SES H 78mm Ø45mm

Clear Dimmable

BC/B22 H 71mm Ø45mm

SBC/B15 H 71mm Ø45mm

SES/E14 H 78 mm Ø45mm

ES/E27 H 78mm Ø45mm

<sup>1</sup>Exceeds EU standard of 70 for Lumens Maintenance Ratio

<sup>2</sup>Exceeds EU standard of RA 80 for Colour Rendering Index

<sup>3</sup>Subject to terms & conditions (Contact Customer Service)

Call Customer Service or see website for maximum loading and dimmer compatibility.





## LED Round

Code	Lamp Type	CCT	Lm	Dim	V	Hours
Non Dimmable						
60520	2.1W LED Round Ball Opal Non Dim - BC	2700K	250	Non Dim	240	25000
60521	2.1W LED Round Ball Opal Non Dim - SES	2700K	250	Non Dim	240	25000
60522	2.1W LED Round Ball Opal Non Dim - ES	2700K	250	Non Dim	240	25000
60523	2.1W LED Round Ball Clear Non Dim - BC	2700K	250	Non Dim	240	25000
60524	2.1W LED Round Ball Clear Non Dim- SES	2700K	250	Non Dim	240	25000
60525	2.1W LED Round Ball Clear Non Dim - ES	2700K	250	Non Dim	240	25000
Dimmable						
60578	2.1W LED Dimmable Round Ball Clear - BC	2700K	250	Dim	240	25000
60579	2.1W LED Dimmable Round Ball Clear - SBC	2700K	250	Dim	240	25000
60580	2.1W LED Dimmable Round Ball Clear - SES	2700K	250	Dim	240	25000
60581	2.1W LED Dimmable Round Ball Clear - ES	2700K	250	Dim	240	25000
60582	2.1W LED Dimmable Round Ball Clear - BC	4000K	250	Dim	240	25000
60583	2.1W LED Dimmable Round Ball Clear - SBC	4000K	250	Dim	240	25000
60584	2.1W LED Dimmable Round Ball Clear - SES	4000K	250	Dim	240	25000
60585	2.1W LED Dimmable Round Ball Clear - ES	4000K	250	Dim	240	25000

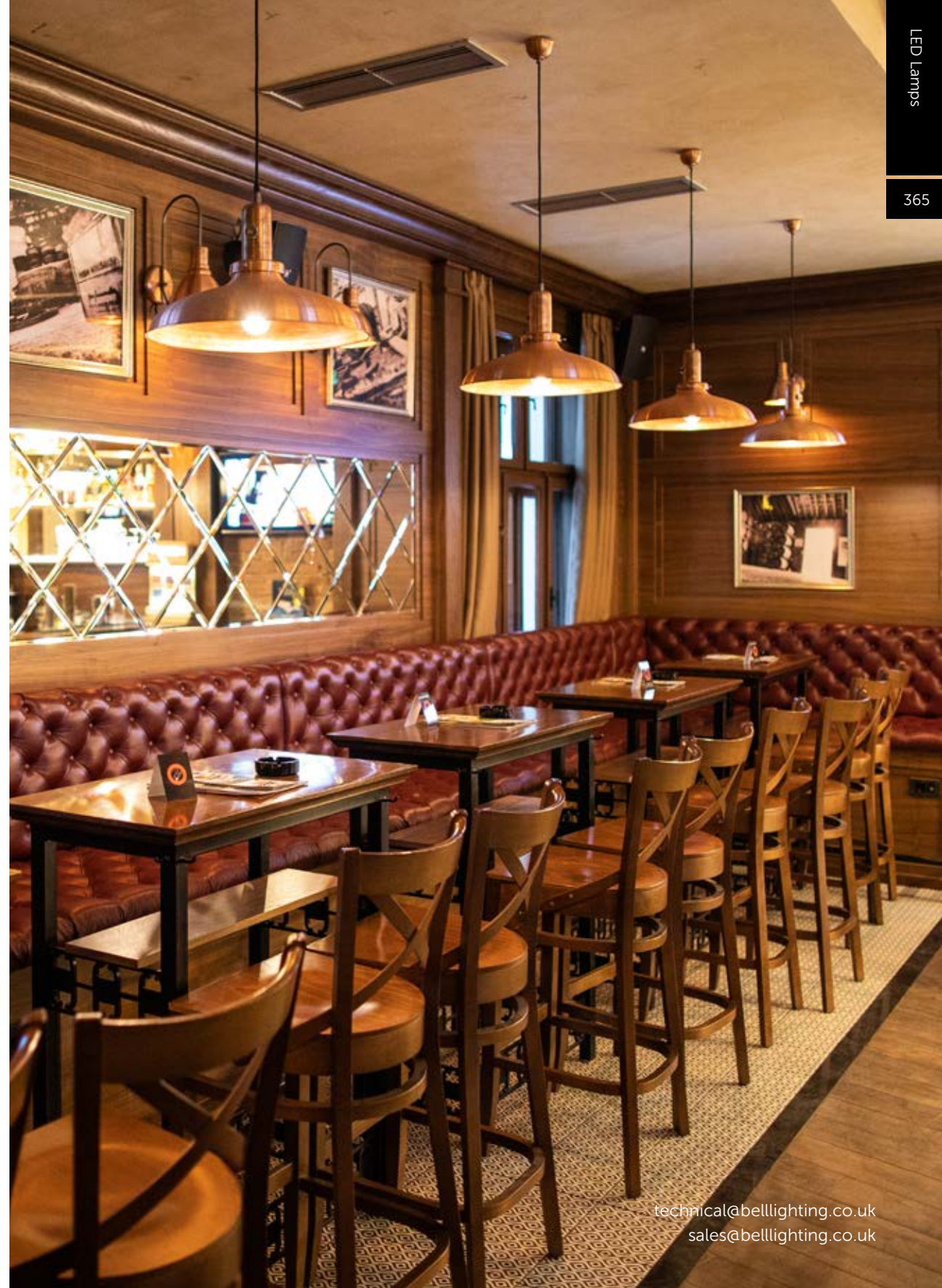





## LED GLS

The most cost-effective way of upgrading inefficient lighting. The foundation of LED Lighting (the SMD Candle, Round & GLS) are lamps that the market has become heavily reliant on over the past 10 years. Our LED GLS comes in 4 different wattage options, Opal finish with Warm White or Cool White output.

- Direct size replacement for Standard GLS
- Suitable for fire-rated fixtures
- 30000 hours



Warm White

Cool White

Opal

3.9W H 95mm Ø55mm

6.6W H 110mm Ø58mm

9.3W H 115mm Ø60mm

13.4W H 115mm Ø60mm

<sup>1</sup> Exceeds EU standard of 70 for Lumens Maintenance Ratio

<sup>2</sup> Exceeds EU standard of RA 80 for Colour Rendering Index

<sup>3</sup> Subject to terms & conditions (Contact Customer Service)

Call Customer Service or see website for maximum loading and dimmer compatibility.





## LED GLS Non Dimmable

Code	Lamp Type	CCT	Lm	Dim	V	Hours
Non Dimmable						
60526	3.9W LED GLS Opal Non Dim - BC	2700K	470	Non Dim	240	30000
60527	3.9W LED GLS Opal Non Dim - ES	2700K	470	Non Dim	240	30000
60528	3.9W LED GLS Opal Non Dim - BC	4000K	470	Non Dim	240	30000
60529	3.9W LED GLS Opal Non Dim - ES	4000K	470	Non Dim	240	30000
60534	6.6W LED GLS Opal Non Dim - BC	2700K	810	Non Dim	240	30000
60535	6.6W LED GLS Opal Non Dim - ES	2700K	810	Non Dim	240	30000
60536	6.6W LED GLS Opal Non Dim - BC	4000K	810	Non Dim	240	30000
60537	6.6W LED GLS Opal Non Dim - ES	4000K	810	Non Dim	240	30000
60546	9.3W LED GLS Opal Non Dim - BC	2700K	1100	Non Dim	240	30000
60547	9.3W LED GLS Opal Non Dim - ES	2700K	1100	Non Dim	240	30000
60548	9.3W LED GLS Opal Non Dim - BC	4000K	1100	Non Dim	240	30000
60549	9.3W LED GLS Opal Non Dim - ES	4000K	1100	Non Dim	240	30000
60554	13.4W LED GLS Opal Non Dim - BC	2700K	1600	Non Dim	240	30000
60555	13.4W LED GLS Opal Non Dim - ES	2700K	1600	Non Dim	240	30000
60556	13.4W LED GLS Opal Non Dim - BC	4000K	1600	Non Dim	240	30000
60557	13.4W LED GLS Opal Non Dim - ES	4000K	1600	Non Dim	240	30000



## LED GLS Dimmable

Code	Lamp Type	CCT	Lm	Dim	V	Hours
Dimmable						
60530	3.9W LED Dimmable GLS Opal - BC	2700K	470	Dim	240	30000
60532	3.9W LED Dimmable GLS Opal - ES	2700K	470	Dim	240	30000
60533	3.9W LED Dimmable GLS Opal - BC	4000K	470	Dim	240	30000
60531	3.9W LED Dimmable GLS Opal - ES	4000K	470	Dim	240	30000
60542	6.6W LED Dimmable GLS Opal - BC	2700K	810	Dim	240	30000
60543	6.6W LED Dimmable GLS Opal - ES	2700K	810	Dim	240	30000
60544	6.6W LED Dimmable GLS Opal - BC	4000K	810	Dim	240	30000
60545	6.6W LED Dimmable GLS Opal - ES	4000K	810	Dim	240	30000
60550	9.3W LED Dimmable GLS Opal - BC	2700K	1100	Dim	240	30000
60551	9.3W LED Dimmable GLS Opal - ES	2700K	1100	Dim	240	30000
60552	9.3W LED Dimmable GLS Opal - BC	4000K	1100	Dim	240	30000
60553	9.3W LED Dimmable GLS Opal - ES	4000K	1100	Dim	240	30000
60558	13.4W LED Dimmable GLS Opal - BC	2700K	1600	Dim	240	30000
60559	13.4W LED Dimmable GLS Opal - ES	2700K	1600	Dim	240	30000
60560	13.4W LED Dimmable GLS Opal - BC	4000K	1600	Dim	240	30000
60561	13.4W LED Dimmable GLS Opal - ES	4000K	1600	Dim	240	30000







## Genesis GLS

The Genesis GLS is our newest edition to the GLS range. This 8.1W GLS is available as Non-Dimmable and Dimmable in 2 colour temperatures. The Genesis GLS offers sleek aesthetics and is destined to be one of our best all-purpose GLS, suitable for multiple applications.

- LED Technology with the elegance of Incandescent Lamps
- Direct size replacement for Standard GLS
- 86% Energy Saving
- Smooth dimming on rotary and digital dimming systems
- Suitable for fire rated fixtures
- 15000 Hours



Opal

Warm White

Cool White

H 110mm Ø58mm

Code	Lamp Type	CCT	Lm	Dim	V	Hours
Non Dim						
60676	8.1W Genesis GLS Non-Dim - ES	2700K	810	Non Dim	240	15000
60677	8.1W Genesis GLS Non-Dim - ES	4000K	810	Non Dim	240	15000
60678	8.1W Genesis GLS Non-Dim - BC	2700K	810	Non Dim	240	15000
60679	8.1W Genesis GLS Non-Dim - BC	4000K	810	Non Dim	240	15000
Dimmable						
60680	8.1W Genesis GLS Dim - ES	2700K	810	Dim	240	15000
60681	8.1W Genesis GLS Dim - ES	4000K	810	Dim	240	15000
60682	8.1W Genesis GLS Dim - BC	2700K	810	Dim	240	15000
60683	8.1W Genesis GLS Dim - BC	4000K	810	Dim	240	15000





## LED Photocell GLS

The LED Photocell GLS is the ideal lamp to reduce the amount of wasted energy while increasing security at any premises. With automatic dusk till dawn switching, this lamp is the lamp of choice for applications such as porches, hallways and suitable IP rated outdoor fixtures.

- Reduce your amount of wasted energy and increase security
- Automatic Dusk Till Dawn Switching
- Ideal for porches, hallways and suitable outdoor fittings
- Dual 360 degree sensors to detect light from all angles
- 806 lumens
- Warm White



Opal

Warm White

H 115mm Ø60mm

Code	Lamp Type	CCT	Lm	Dim	V	Hours
Non Dimmable						
60660	7W LED GLS - BC, Photocell	2700K	806	Non Dim	240	25000
60661	7W LED GLS - ES, Photocell	2700K	806	Non Dim	240	25000
Automatic dusk till dawn switching						

<sup>1</sup>Exceeds EU standard of 70 for Lumens Maintenance Ratio

<sup>2</sup>Exceeds EU standard of RA 80 for Colour Rendering Index

<sup>3</sup>Subject to terms & conditions (Contact Customer Service)

Call Customer Service or see website for maximum loading and dimmer compatibility.



Opal

Warm White

H 115mm Ø60mm

Code	Lamp Type	CCT	Lm	Dim	V	Hours
Non Dimmable						
60660	7W LED GLS - BC, Photocell	2700K	806	Non Dim	240	25000
60661	7W LED GLS - ES, Photocell	2700K	806	Non Dim	240	25000
Automatic dusk till dawn switching						

<sup>1</sup>Exceeds EU standard of 70 for Lumens Maintenance Ratio

<sup>2</sup>Exceeds EU standard of RA 80 for Colour Rendering Index

<sup>3</sup>Subject to terms & conditions (Contact Customer Service)

Call Customer Service or see website for maximum loading and dimmer compatibility.



## LED Reflector

The ever-popular LED Reflectors are ideal for multiple applications. Available in 5 different sizes, 3 different wattages and 2 different cap types.

- Direct replacement for incandescent reflector spots
- Long life of 25,000 hours
- Low maintenance costs
- Sustainable lighting technology



Warm White

R39 H 69.5mm Ø39mm

R50 H 87mm Ø50mm

R63 H 100mm Ø63mm

R80 H 110mm Ø80mm

Code	Lamp Type	CCT	Lm	Dim	V	Hours
Non Dimmable						
05680	4W LED R39 Non Dim - SES	3000K	300	Non Dim	240	25000
05683	6W LED R50 Non Dim - SES	3000K	450	Non Dim	240	25000
05681	6W LED R63 Non Dim - ES	3000K	450	Non Dim	240	25000
05684	6W LED R80 Non Dim - ES	3000K	500	Non Dim	240	25000
05682	9W LED R80 Non Dim - ES	3000K	800	Non Dim	240	25000

<sup>1</sup>Exceeds EU standard of 70 for Lumens Maintenance Ratio

<sup>2</sup>Exceeds EU standard of RA 80 for Colour Rendering Index

<sup>3</sup>Subject to terms & conditions (Contact Customer Service)

Call Customer Service or see website for maximum loading and dimmer compatibility.





## LED Appliance Lamp

Our LED Appliance Lamps are the ideal replacements for inefficient Incandescent lighting. With up to 25,000 hours lamp life and up to a 5 year warranty these lamps are truly a fit & forget product.

- Direct replacement for standard Cooker Hood, Pygmy & Appliance lamps
- Shatterproof, suitable for signage and domestic applications



Warm White

Cool White

Cooker Hood H 85mm Ø23mm

Pygmy Lamp H 57mm Ø27mm

Code	Lamp Type	CCT	Lm	Dim	V	Hours
Non Dimmable						
05655	3W LED Cooker Hood Non Dim - SES Clear	3000K	350	Non Dim	240	25000
60044	3W LED Cooker Hood Non Dim - SES Clear	4000K	350	Non Dim	240	25000
05663	2W Pygmy Lamp Non Dim - SES Clear	2700K	100	Non Dim	240	15000
05664	2W Pygmy Lamp Non Dim - SES Opal	2700K	90	Non Dim	240	15000



## LED Appliance Lamp

Our LED Appliance Lamps are the ideal replacements for inefficient Incandescent lighting. With up to 25,000 hours lamp life and up to a 5 year warranty these lamps are truly a fit & forget product.

- Direct replacement for standard Cooker Hood, Pygmy & Appliance lamps
- Shatterproof, suitable for signage and domestic applications



Warm White

Cool White

Cooker Hood H 85mm Ø23mm

Pygmy Lamp H 57mm Ø27mm

Code	Lamp Type	CCT	Lm	Dim	V	Hours
Non Dimmable						
05655	3W LED Cooker Hood Non Dim - SES Clear	3000K	350	Non Dim	240	25000
60044	3W LED Cooker Hood Non Dim - SES Clear	4000K	350	Non Dim	240	25000
05663	2W Pygmy Lamp Non Dim - SES Clear	2700K	100	Non Dim	240	15000
05664	2W Pygmy Lamp Non Dim - SES Opal	2700K	90	Non Dim	240	15000



<sup>1</sup>Exceeds EU standard of 70 for Lumens Maintenance Ratio

<sup>2</sup>Exceeds EU standard of RA 80 for Colour Rendering Index

<sup>3</sup>Subject to terms & conditions (Contact Customer Service)

Call Customer Service or see website for maximum loading and dimmer compatibility.



## LED G4/G9 Capsules

Our sleek looking LED G9 Capsules can be used in both open & closed fixtures. The Opal finish enables them to seamlessly blend into any light fixture while providing a high light output.

- Ideal for domestic & commercial applications
- Colour Rendering Index >90 G9 version available
- Warm White 2700K & Cool White 4000K
- Direct retrofit into existing fittings.
- Perfect for display and accent light fixtures
- Up to 92% Energy saving
- Up to 20000 Hours



G9 3.5W Versions



Warm White

Cool White

1.4W G4 H 40mm W 15mm

2W G9 H 56mm W 15mm

3.5W G9 H 54mm W 18mm

Code	Lamp Type	CCT	Lm	Dim	V	Hours
Non Dimmable						
05645	1.4W LED G4 Capsule - Non Dim	2700K	140	Non Dim	12	15000
12V intensity LED bulbs require a BELL line driver or quality branded transformer						
Dimmable						
05674	2W LED G9 Capsule - Dimmable	2700K	210	Dim	240	20000
60043	2W LED G9 Capsule - Dimmable	4000K	210	Dim	240	20000
60227	3.5W LED G9 Capsule - Dimmable	2700K	470	Dim	240	15000
60226	3.5W LED G9 Capsule - Dimmable	4000K	470	Dim	240	15000
Compatible with most branded Trailing Edge Dimmers including BELL Smart Universal LED Trailing/Leading Edge Dimmer Module. Code: 10803						

<sup>1</sup> Exceeds EU standard of 70 for Lumens Maintenance Ratio

<sup>2</sup> Exceeds EU standard of RA 80 for Colour Rendering Index

<sup>3</sup> Subject to terms & conditions (Contact Customer Service)

Call Customer Service or see website for maximum loading and dimmer compatibility.

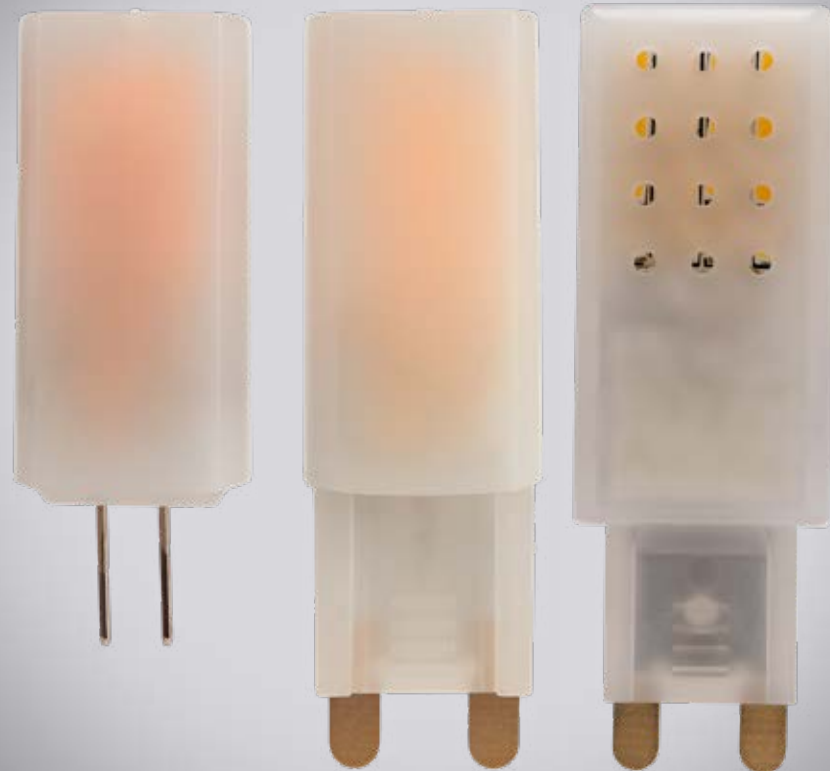



## LED Square 2/4 Pin

Our LED Square 2/4 Pin Lamps give the user the familiarity of the renowned CFL Square Lamps combined with the energy saving benefits of LED lighting. With a 3 year warranty, these 16W & 28W CFL replacements will stand the test of time.

- Replacement for CFL Square lamps
- Same aesthetic as CFL Square lamp but reduced energy consumption
- Retrofit
- 25000 Hours
- Perfect for commercial & domestic applications
- Quick, easy installation



Warm White

8W H 128mm W 150mm D 24mm

16W H 182mm W 211mm D 24mm

Code	Lamp Type	CCT	Lm	Dim	V	Hours
Non Dimmable						
60455	8W Square LED 2D Lamp - GR8	3000K	880	Non Dim	220-240	25000
60456	16W Square LED 2D Lamp - GR10q	3000K	1800	Non Dim	220-240	25000

For use with magnetic ballast: Remove starter and capacitor

For use with electronic ballast: Remove control gear and wire directly to mains

Not suitable for emergency

<sup>1</sup>Exceeds EU standard of 70 for Lumens Maintenance Ratio

<sup>2</sup>Exceeds EU standard of RA 80 for Colour Rendering Index

<sup>3</sup>Subject to terms & conditions (Contact Customer Service)

Call Customer Service or see website for maximum loading and dimmer compatibility.

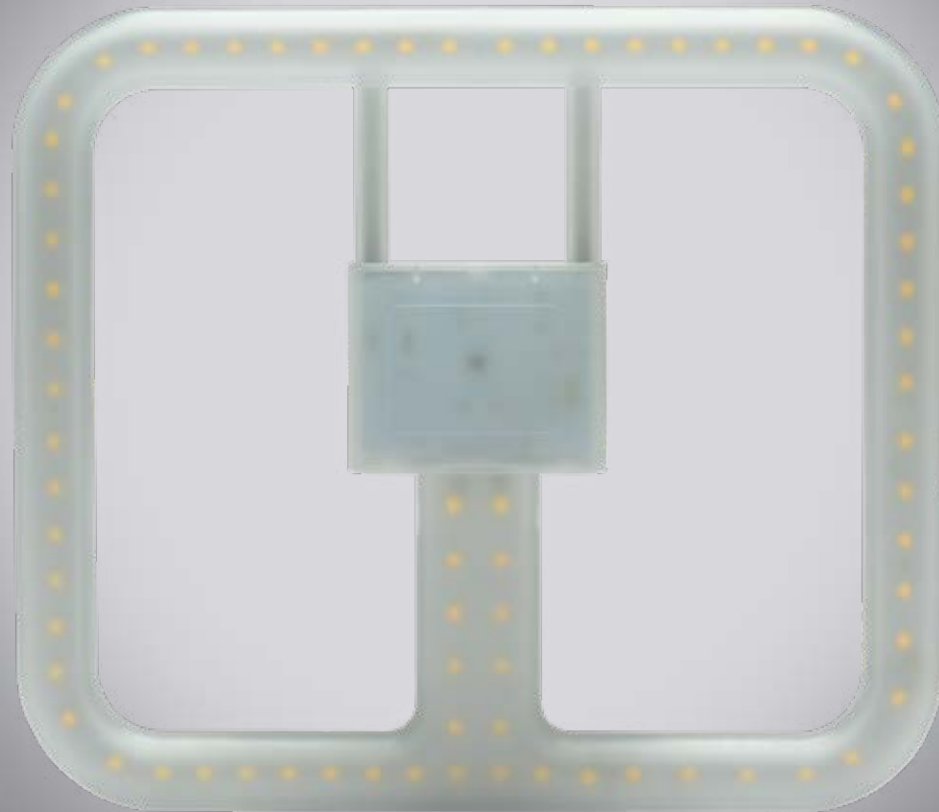





## 110V LED GLS

The 110V LED GLS has been specially designed for safety applications. As a direct replacement for standard GLS, this tough, robust GLS is suitable for site lighting, with a colour coded yellow base for easy identification.

- Suitable for site lighting
- Direct replacement for standard GLS
- Retrofit size
- Suitable for use with low voltage site transformers
- Colour coded yellow base for easy identification
- 89% Energy Saving
- IP65 when used with suitable lamp holder
- Tough, robust design
- Plastic envelope



Cool White  
 Warm White  
 Opal  
 H 103mm Ø57mm

Code	Lamp Type	CCT	Lm	Dim	V	Hours
Non Dimmable						
60538	6.6W LED 110V GLS Non Dim - BC	2700K	810	Non Dim	110	25000
60539	6.6W LED 110V GLS Non Dim - ES	2700K	810	Non Dim	110	25000
60540	6.6W LED 110V GLS Non Dim - BC	4000K	810	Non Dim	110	25000
60541	6.6W LED 110V GLS Non Dim - ES	4000K	810	Non Dim	110	25000

<sup>1</sup>Exceeds EU standard of 70 for Lumens Maintenance Ratio

<sup>2</sup>Exceeds EU standard of RA 80 for Colour Rendering Index

<sup>3</sup>Subject to terms & conditions (Contact Customer Service)

Call Customer Service or see website for maximum loading and dimmer compatibility.





## LED BLD/BLT

The LED BLD/BLT Lamps are an ideal replacement for old hat CFL technology. With a 3 year warranty the LED BLD/BLT Lamps offer a cost-effective energy saving solution without the need to replace a complete fitting.

- Energy saving benefits of LED without having to change fittings
- True retrofit size
- High CRI
- Not suitable for emergency or dimming
- Must bypass all existing control gear



Cool White

6.5W BL H 118mm Ø32mm

8.5W BL H 118mm Ø32mm

12W BL H 124mm Ø44mm

Code	Lamp Type	CCT	Lm	Dim	V	Hours
Non Dimmable						
60450	6.5W LED BL - 2/4 Pin, Non Dim G24d/Gx24q	4000K	806	Non Dim	240	15000
60451	8.5W LED BL - 2/4 Pin, Non Dim G24d/Gx24q	4000K	1055	Non Dim	240	15000
60452	12W LED BL - 2/4 Pin, Non Dim G24d/Gx24q	4000K	1521	Non Dim	240	15000

For use with electronic/magnetic ballast: Remove control gear and wire directly to mains  
Not suitable for emergency

<sup>1</sup>Exceeds EU standard of 70 for Lumens Maintenance Ratio

<sup>2</sup>Exceeds EU standard of RA 80 for Colour Rendering Index

<sup>3</sup>Subject to terms & conditions (Contact Customer Service)

Call Customer Service or see website for maximum loading and dimmer compatibility.





## LED BLL/BLS

The LED BLL/BLS Lamps are an ideal replacement for old hat CFL technology. With a 5 year warranty the LED BLL Lamps offer a cost-effective energy saving solution without the need to replace a complete fitting. Ideal for public buildings, offices, shops, supermarkets, hotels, restaurants and around the home.

- Energy saving benefits of LED without having to change fittings
- Aluminium heat sink for improved life
- True retrofit size
- High CRI
- Not suitable for emergency or dimming
- Suitable for switch start/magnetic control gear
- Must bypass High Frequency control gear



Cool White

8W BLL L 240mm W 48mm

15W BLL L 430mm W 48mm

24W BLL L 550mm W 48mm

4.5W BLS L 166mm W 32mm

Code	Lamp Type	CCT	Lm	Dim	V	Hours
Non Dimmable						
04328	8W LED Linear 4 Pin Non Dim - 2G11	4000K	720	Non Dim	240	45000
04329	15W LED Linear 4 Pin Non Dim - 2G11	4000K	1350	Non Dim	240	45000
04330	24W LED Linear 4 Pin Non Dim - 2G11	4000K	2160	Non Dim	240	45000
04331	4.5W LED BLS 2 Pin Non Dim - G23	4000K	405	Non Dim	240	45000

For use with magnetic ballast: Remove starter and capacitor

For use with electronic ballast: Remove control gear and wire directly to mains

Not suitable for emergency

<sup>1</sup> Exceeds EU standard of 70 for Lumens Maintenance Ratio

<sup>2</sup> Exceeds EU standard of RA 80 for Colour Rendering Index

<sup>3</sup> Subject to terms & conditions (Contact Customer Service)

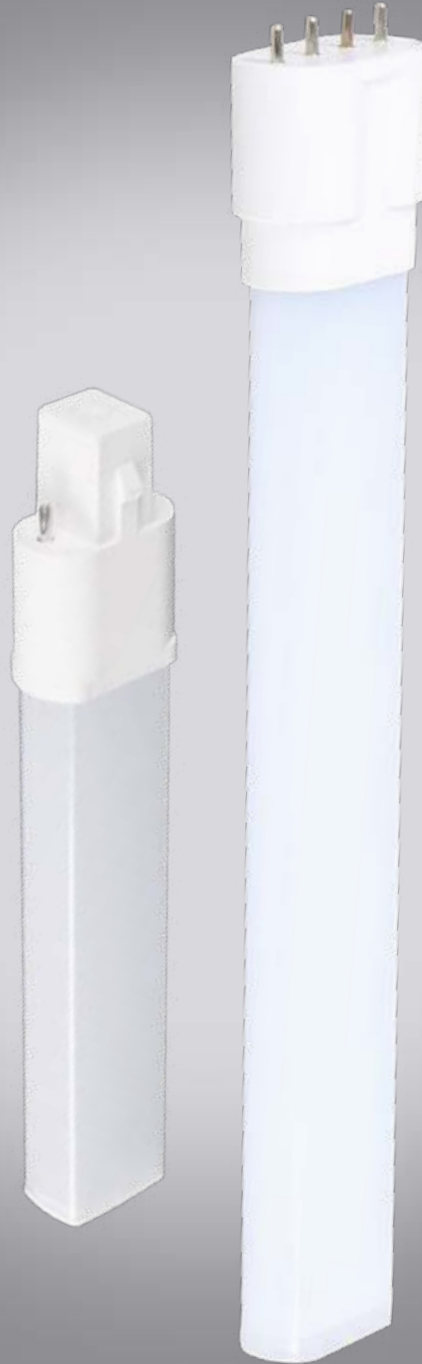





## LED Strip

Our LED Strip Lamps are a perfect replacement for inefficient incandescent lighting. With a 3 year warranty, these lamps offer a cost effective way to upgrade lighting without the need for a full replacement of a fitting or fixture.

- Direct size replacement for Standard Strip Lamp
- Lasts 15 times longer than Standard Strip Lamp
- 90% Energy Saving
- 20000 hours



Opal

Warm White

3W Strip L 221mm Ø26mm

5.5W Strip L 284mm Ø26mm



Code	Lamp Type	CCT	Lm	Dim	V	Hours
Non Dimmable						
05156	3W LED 221mm Opal Strip Lamp Non Dim S15	3000K	360	Non Dim	240	20000
05157	5.5W LED 284mm Opal Strip Lamp Non Dim S15	3000K	600	Non Dim	240	20000

<sup>1</sup>Exceeds EU standard of 70 for Lumens Maintenance Ratio

<sup>2</sup>Exceeds EU standard of RA 80 for Colour Rendering Index

<sup>3</sup>Subject to terms & conditions (Contact Customer Service)

Call Customer Service or see website for maximum loading and dimmer compatibility.





## LED T8

Our LED T8 tubes are suitable for both switch start and high frequency and are the perfect way to replace conventional fluorescent tubes. A cost-effective energy saving solution without the need to replace a complete fitting while reaping the energy saving benefits of LED.

- Designed to replace conventional fluorescent tubes
- Long life up to 25000 hours
- Low maintenance costs
- Up to 67% Energy Savings
- Simple Retrofit
- Emergency pack available



Frosted Glass

Cool White

Daylight

Tube Ø 28mm

8.5W L 600mm

13W L 900mm

16W L 1200mm

21W L 1500mm

23W L 1800mm





## LED T8

Code	Lamp Type	CCT	Lm	Dim	V	Hours
Non Dimmable						
60230	8.5W LED T8 Tube - G13, 600mm	4000K	1100	Non Dim	240	25000
60231	13W LED T8 Tube - G13, 900mm	4000K	1600	Non Dim	240	25000
60232	16W LED T8 Tube - G13, 1200mm	4000K	2000	Non Dim	240	25000
60233	21W LED T8 Tube - G13, 1500mm	4000K	2600	Non Dim	240	25000
60235	21W LED T8 Tube - G13, 1500mm	6500K	2600	Non Dim	240	25000
60234	23W LED T8 Tube - G13, 1800mm	4000K	3200	Non Dim	240	25000
08743	Emergency Pack for LED Tubes - Non Self Test	-	-	-	-	-
08744	Emergency Pack for LED Tubes - Self Test	-	-	-	-	-

For use with magnetic ballast: Remove starter and capacitor  
 For use with electronic ballast: Remove control gear and wire directly to mains

Emergency versions must be tested in line with the requirements of BS5266, failure to do so may effect battery life and warranty.

<sup>1</sup> Exceeds EU standard of 70 for Lumens Maintenance Ratio

<sup>2</sup> Exceeds EU standard of RA 80 for Colour Rendering Index

<sup>3</sup> Subject to terms & conditions (Contact Customer Service)

Call Customer Service or see website for maximum loading and dimmer compatibility.

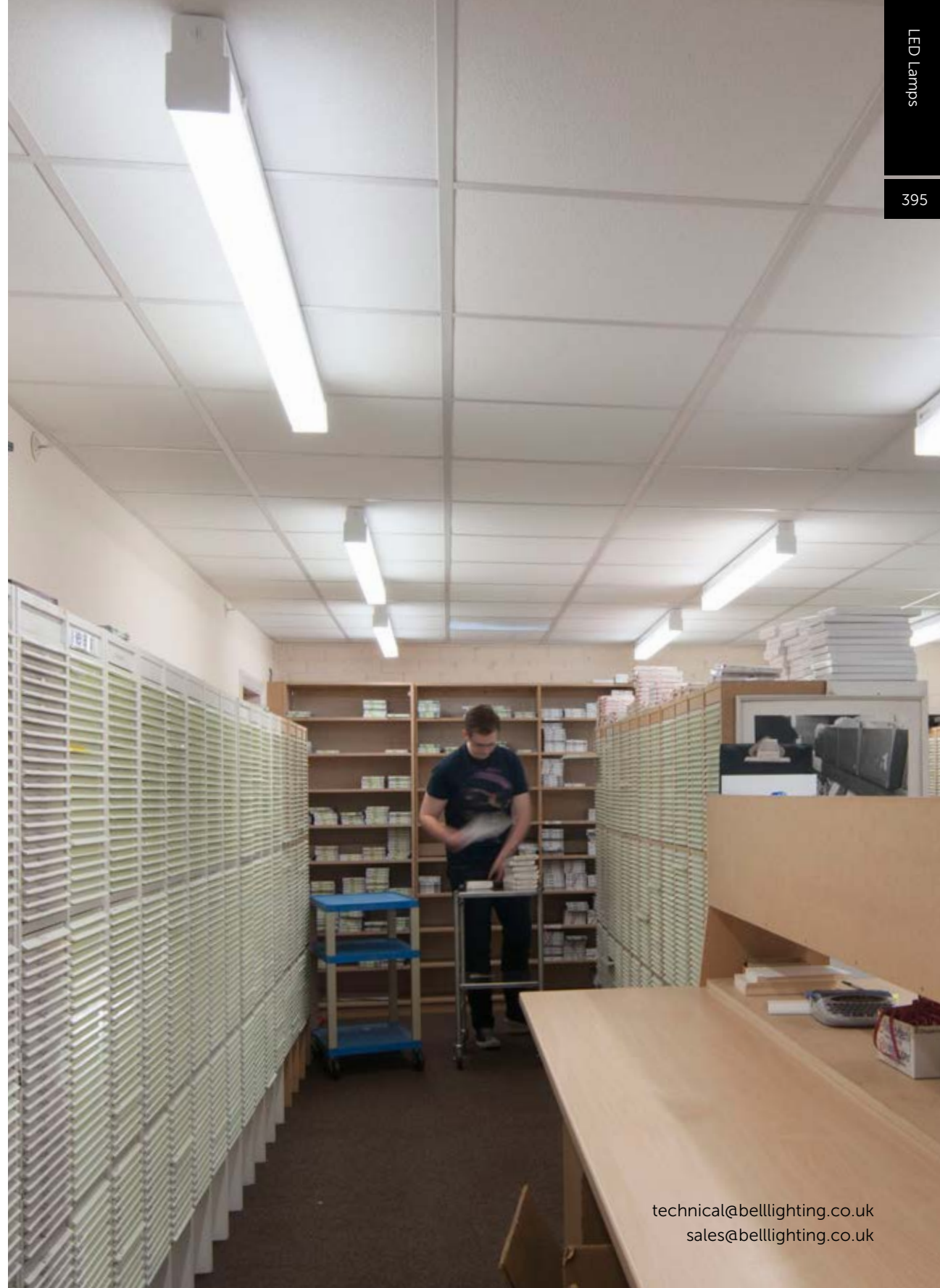





## LED T5

Our LED T5 tubes are suitable for both switch start and high frequency and are the perfect way to replace conventional fluorescent tubes. A cost-effective energy saving solution without the need to replace a complete fitting while reaping the energy saving benefits of LED.

- Designed to replace conventional fluorescent tubes.
- Long life 45000 hours
- Low maintenance costs
- 5 Year Warranty
- Up to 49% Energy Savings



Frosted Glass

Cool White

Tube Ø 20mm

9W L 549mm

12W L 849mm

16W L 1149mm

19W L 1449mm

25W L 1449mm





## LED T5

Code	Lamp Type	CCT	Lm	Dim	V	Hours
Non Dimmable						
04338	9W LED T5 HE Tube - G5, Non Dim, 549mm	4000K	950	Non Dim	240	45000
04339	12W LED T5 HE Tube - G5, Non Dim, 849mm	4000K	1440	Non Dim	240	45000
04340	16W LED T5 HE Tube - G5, Non Dim, 1149mm	4000K	2100	Non Dim	240	45000
04341	19W LED T5 HE Tube - G5, Non Dim, 1449mm	4000K	2500	Non Dim	240	45000
04343	25W LED T5 HO Tube - G5, Non Dim, 1449mm	4000K	3500	Non Dim	240	45000

For use with magnetic ballast: Remove starter and capacitor  
 For use with electronic ballast: Remove control gear and wire directly to mains  
 Not suitable for emergency

<sup>1</sup> Exceeds EU standard of 70 for Lumens Maintenance Ratio  
<sup>2</sup> Exceeds EU standard of RA 80 for Colour Rendering Index  
<sup>3</sup> Subject to terms & conditions (Contact Customer Service)  
 Call Customer Service or see website for maximum loading and dimmer compatibility.

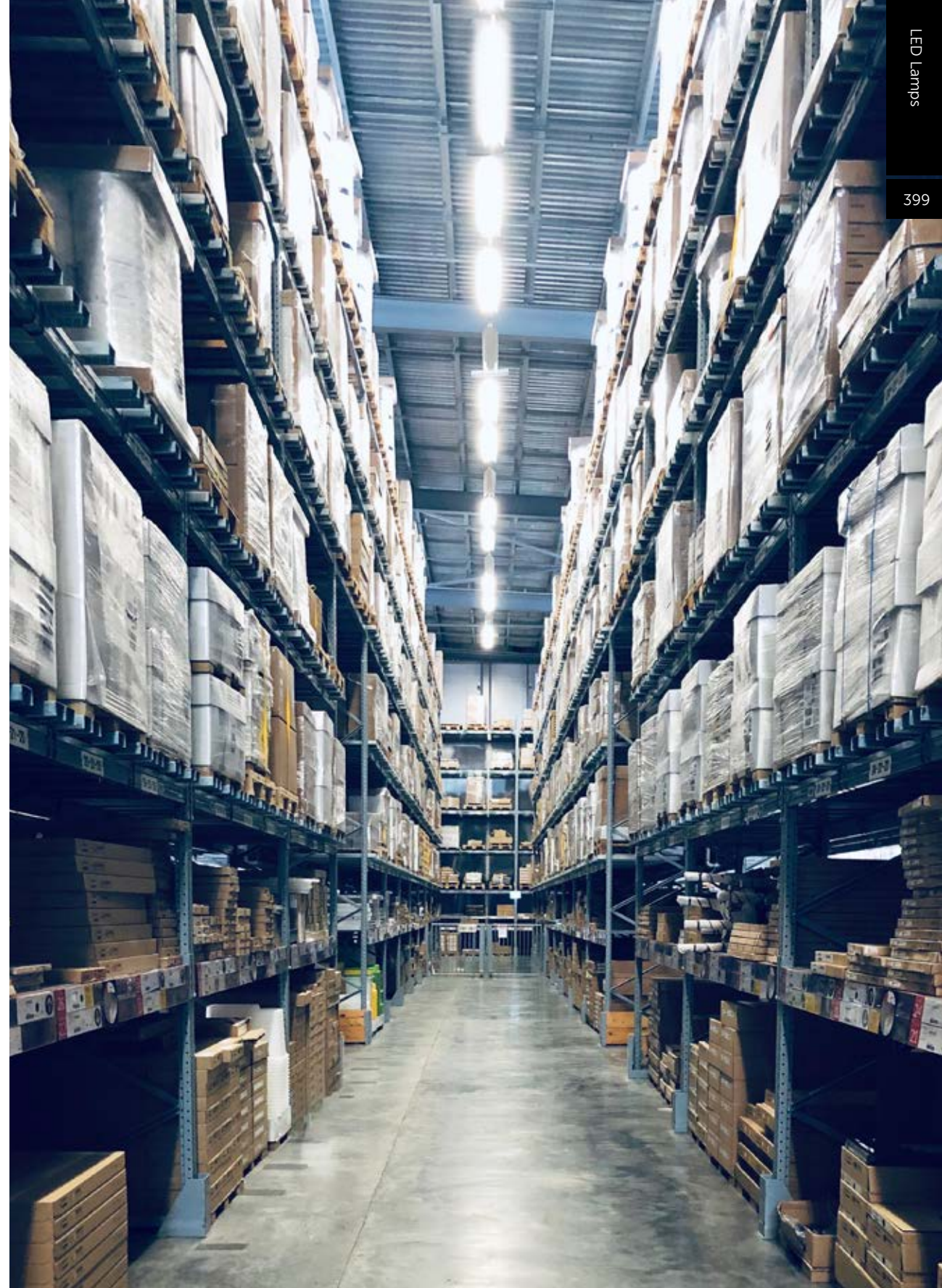



## BLD

Available in a variety of wattages and caps in Warm White, White & Cool White colour temperatures, this long-lasting lamp is ideal for functional domestic and commercial applications.

- Quick Start Technology
- 10000 Hours
- Last up to 10 times longer than a standard lamp

Cool White

Warm White

White

10W L 119mm W 27mm

13W L 137mm W 27mm

18W L 153mm W 27mm

26W L 173mm W 27mm

Code	Lamp Type	CCT	Lm	Dim	V	Hours
Non Dimmable						
04150	10W BLD - 2 Pin Non Dim	4000K	600	Non Dim	-	10000
04151	13W BLD - 2 Pin Non Dim	4000K	900	Non Dim	-	10000
04158	13W BLD - 4 Pin Non Dim	4000K	900	Non Dim	-	10000
04231	13W BLD - 2 Pin Non Dim	3500K	900	Non Dim	-	10000
04247	13W BLD - 4 Pin Non Dim	3500K	900	Non Dim	-	10000
04232	18W BLD - 2 Pin Non Dim	3500K	1200	Non Dim	-	10000
04153	26W BLD - 2 Pin Non Dim	4000K	1800	Non Dim	-	10000
04160	26W BLD - 4 Pin Non Dim	4000K	1800	Non Dim	-	10000
04233	26W BLD - 2 Pin, Non Dim	3500K	1800	Non Dim	-	10000
04249	26W BLD - 4 Pin Non Dim	3500K	1800	Non Dim	-	10000



## BLT

The CFL BLT lamps are available in a variety of wattages and caps in Cool White colour temperature, this long-lasting lamp is ideal for functional domestic and commercial applications.

- Quick Start Technology
- 10000 Hours
- Last up to 10 times longer than a standard lamp

### Cool White

13W L 110mm W 42mm

18W L 125mm W 42mm

26W L 145mm W 42mm

32W L 150mm W 42mm

42W L 168mm W 42mm

Code	Lamp Type	CCT	Lm	Dim	V	Hours
Non Dimmable						
04166	13W BLT - 4 Pin, Non Dim	4000K	900	Non Dim	-	10000
04165	18W BLT - 2 Pin, Non Dim	4000K	1200	Non Dim	-	10000
04167	18W BLT - 4 Pin, Non Dim	4000K	1200	Non Dim	-	10000
04168	26W BLT - 2 Pin, Non Dim	4000K	1800	Non Dim	-	10000
04169	26W BLT - 4 Pin, Non Dim	4000K	1800	Non Dim	-	10000
04277	32W BLT - 4 Pin, Non Dim	4000K	2400	Non Dim	-	10000
04278	42W BLT - 4 Pin, Non Dim	4000K	3200	Non Dim	-	10000





## BLS

The CFL BLS range features a G23 base and a White & Cool White colour temperature, this long-lasting lamp is ideal for functional domestic and commercial applications.

- Quick Start Technology
- 10000 Hours
- Last up to 10 times longer than a standard lamp

Cool White

White

5W L 105mm W 32 mm

9W L 164mm W 32mm

11W L 233mm W 32mm

Code	Lamp Type	CCT	Lm	Dim	V	Hours
Non Dimmable						
04200	5W BLS - 2 Pin, Non Dim	4000K	250	Non Dim	-	10000
04202	9W BLS - 2 Pin, Non Dim	4000K	600	Non Dim	-	10000
04211	9W BLS - 2 Pin, Non Dim	3500K	600	Non Dim	-	10000
04203	11W BLS - 2 Pin, Non Dim	4000K	900	Non Dim	-	10000
04212	11W BLS - 2 Pin, Non Dim	3500K	900	Non Dim	-	10000



## BLS

The CFL BLS range features a G23 base and a White & Cool White colour temperature, this long-lasting lamp is ideal for functional domestic and commercial applications.

- Quick Start Technology
- 10000 Hours
- Last up to 10 times longer than a standard lamp

Cool White

White

5W L 105mm W 32 mm

9W L 164mm W 32mm

11W L 233mm W 32mm

Code	Lamp Type	CCT	Lm	Dim	V	Hours
Non Dimmable						
04200	5W BLS - 2 Pin, Non Dim	4000K	250	Non Dim	-	10000
04202	9W BLS - 2 Pin, Non Dim	4000K	600	Non Dim	-	10000
04211	9W BLS - 2 Pin, Non Dim	3500K	600	Non Dim	-	10000
04203	11W BLS - 2 Pin, Non Dim	4000K	900	Non Dim	-	10000
04212	11W BLS - 2 Pin, Non Dim	3500K	900	Non Dim	-	10000



## BLS

The CFL BLS range features a G23 base and a White & Cool White colour temperature, this long-lasting lamp is ideal for functional domestic and commercial applications.

- Quick Start Technology
- 10000 Hours
- Last up to 10 times longer than a standard lamp

Cool White

White

5W L 105mm W 32 mm

9W L 164mm W 32mm

11W L 233mm W 32mm

Code	Lamp Type	CCT	Lm	Dim	V	Hours
Non Dimmable						
04200	5W BLS - 2 Pin, Non Dim	4000K	250	Non Dim	-	10000
04202	9W BLS - 2 Pin, Non Dim	4000K	600	Non Dim	-	10000
04211	9W BLS - 2 Pin, Non Dim	3500K	600	Non Dim	-	10000
04203	11W BLS - 2 Pin, Non Dim	4000K	900	Non Dim	-	10000
04212	11W BLS - 2 Pin, Non Dim	3500K	900	Non Dim	-	10000





## BLL

The CFL BLL range features a 2G11 base and a White & Cool White colour temperature. This long-lasting lamp is ideal for functional domestic and commercial applications.

- Quick Start Technology
- 10000 Hours
- Lasts up to 10 times longer than a standard lamp

### Cool White

18W L 225mm W 40mm

24W L 320mm W 40mm

36W L 418mm W 40mm

40W L 538mm W 40mm

55W L 538mm W 40mm

Code	Lamp Type	CCT	Lm	Dim	V	Hours
Non Dimmable						
04302	18W BLL - 4 Pin Non Dim	4000K	1200	Dim	-	10000
04305	40W BLL - 4 Pin Non Dim	4000K	3325	Dim	-	10000
04306	55W BLL - 4 Pin Non Dim	4000K	4800	Dim	-	10000



## T9 Triphosphor Circular

The T9 Triphosphor range features a G10q base and a White & Cool White colour temperature, this long-lasting lamp is ideal for functional domestic and commercial applications.

- Quick Start Technology
- 16000 Hours
- Last up to 10 times longer than a standard lamp

Cool White

White

22W Overall Ø210 mm

32W Overall Ø300 mm

40W Overall Ø400 mm

60W Overall Ø400 mm

Tube Ø29 mm

Code	Lamp Type	CCT	Lm	Dim	V	Hours
Non Dimmable						
04194	22W T9 Triphosphor Circular Tube Non Dim - 4 Pin	4100K	1300	Non Dim	-	16000
04191	32W T9 Triphosphor Circular Tube Non Dim - 4 Pin	3000K	2450	Non Dim	-	16000
04192	40W T9 Triphosphor Circular Tube Non Dim - 4 Pin	3000K	3450	Non Dim	-	16000
04196	40W T9 Triphosphor Circular Tube Non Dim - 4 Pin	4100K	3200	Non Dim	-	16000
04193	60W T9 Triphosphor Circular Tube Non Dim - 4 Pin	3000K	4300	Non Dim	-	16000
04197	60W T9 Triphosphor Circular Tube Non Dim - 4 Pin	4100K	4100	Non Dim	-	16000





## T5 Triphosphor Circular

The T5 Triphosphor range features a 2GX13 base and a White & Cool White colour temperature, this long-lasting lamp is ideal for functional domestic and commercial applications.

- Quick Start Technology
- 16000 Hours
- Last up to 10 times longer than a standard lamp

Cool White

White

22W Overall Ø225 mm

40W Overall Ø299 mm

55W Overall Ø299 mm

60W Overall Ø373 mm

Tube Ø16 mm

Code	Lamp Type	CCT	Lm	Dim	V	Hours
Non Dimmable						
05460	22W T5 Circular Tube - Non Dim 2GX13	4000K	1900	Non Dim	-	16000
05463	40W T5 Circular Tube - Non Dim 2GX13	4000K	3350	Non Dim	-	16000
05466	55W T5 Circular Tube - Non Dim 2GX13	4000K	4300	Non Dim	-	16000
05469	60W T5 Circular Tube - Non Dim 2GX13	4000K	5000	Non Dim	-	16000



## Square

Our CFL Square Lamps are the perfect low-profile bulb for surface mounted fittings, corridors, bathrooms and bulkheads. Available in Warm White, White & Cool White, the CFL Square Lamps are a tried and tested product suitable for both domestic & commercial applications.

- Quick Start Technology
- 10000 Hours
- Last up to 10 times longer than a standard lamp

Cool White

Warm White

White

16W H 135mm W 135mm D 30mm

28W H 205mm W 205mm D 30mm

38W H 205mm W 205mm D 30mm

Code	Lamp Type	CCT	Lm	Dim	V	Hours
Non Dimmable						
04170	16W Square - Non Dim 2 Pin	3500K	1050	Non Dim	-	10000
04183	16W Square - Non Dim 2 Pin	2700K	1050	Non Dim	-	10000
04131	16W Square - Non Dim 2 Pin	4000K	1050	Non Dim	-	10000
04133	16W Square - Non Dim 4 Pin	4000K	1050	Non Dim	-	10000
04171	28W Square - Non Dim 2 Pin	3500K	2050	Non Dim	-	10000
04184	28W Square - Non Dim 2 Pin	2700K	2050	Non Dim	-	10000
04132	28W Square - Non Dim 2 Pin	4000K	2050	Non Dim	-	10000
04134	28W Square - Non Dim 4 Pin	4000K	2050	Non Dim	-	10000
04180	38W Square - Non Dim 4 Pin	3500K	2700	Non Dim	-	10000
04135	38W Square - Non Dim 4 Pin	4000K	2700	Non Dim	-	10000





## T5 Triphosphor Mini Tube

Fluorescent Tubes are commonly used in recessed lighting applications. This quality light source offers high lumen maintenance and good colour rendering. This energy efficient lamp offers an impressive 5,000 hour lamp life.

- 5000 Hours

Cool White

White

Length measurement is from pin end to pin end

Tube Ø16 mm

Code	Lamp Type	CCT	Lm	Dim	V	Hours
Non Dimmable						
05405	4W T5 Halophosphor Mini Tube, 150mm	3500K	150	Non Dim	-	5000
05406	4W T5 Halophosphor Mini Tube, 150mm	4000K	150	Non Dim	-	5000
05407	6W T5 Halophosphor Mini Tube, 225mm	3500K	260	Non Dim	-	5000
05408	6W T5 Halophosphor Mini Tube, 225mm	4000K	260	Non Dim	-	5000
05409	8W T5 Halophosphor Mini Tube, 300mm	3500K	380	Non Dim	-	5000
05410	8W T5 Halophosphor Mini Tube, 300mm	4000K	380	Non Dim	-	5000
05411	13W T5 Halophosphor Mini Tube, 525mm	3500K	800	Non Dim	-	5000
05412	13W T5 Halophosphor Mini Tube, 525mm	4000K	800	Non Dim	-	5000
12055	4W - 80W Starter	-	-	-	-	-
12056	4W - 22W Series Starter	-	-	-	-	-
12057	70W - 125W Starter	-	-	-	-	-
12059	4W - 125W Electronic Starter	-	-	-	-	-

All 25 way or 40 way outer boxes are individually bubble wrapped to avoid breakages in transit.

WEEE Registration Number: Wee/GJ0117XV

No Additional Charge on Invoice



## T5 Triphosphor High Efficiency Tube

Fluorescent Tubes are commonly used in recessed lighting applications. This quality light source offers high lumen maintenance and good colour rendering. This energy efficient lamp offers an impressive 20,000 hour lamp life.

- 20000 Hours

Cool White

White

Daylight

Tube Ø16mm

Length measurement is from pin end to pin end



Code	Lamp Type	CCT	Lm	Dim	V	Hours
Non Dimmable						
05415	14W T5 Triphosphor H/E Tube Non Dim - 549mm	4000K	1200	Non Dim	-	20000
05416	14W T5 Triphosphor H/E Tube Non Dim - 549mm	6500K	1100	Non Dim	-	20000
05417	14W T5 Triphosphor H/E Tube Non Dim - 549mm	3500K	1200	Non Dim	-	20000
05418	21W T5 Triphosphor H/E Tube Non Dim - 849mm	4000K	1900	Non Dim	-	20000
05419	21W T5 Triphosphor H/E Tube Non Dim - 849mm	6500K	1900	Non Dim	-	20000
05420	21W T5 Triphosphor H/E Tube Non Dim - 849mm	3500K	2000	Non Dim	-	20000
05421	28W T5 Triphosphor H/E Tube Non Dim - 1149mm	4000K	2600	Non Dim	-	20000
05422	28W T5 Triphosphor H/E Tube Non Dim - 1149mm	6500K	2400	Non Dim	-	20000
05423	28W T5 Triphosphor H/E Tube Non Dim - 1149mm	3500K	2600	Non Dim	-	20000
05424	35W T5 Triphosphor H/E Tube Non Dim - 1449mm	4000K	3300	Non Dim	-	20000
05425	35W T5 Triphosphor H/E Tube Non Dim - 1449mm	6500K	3000	Non Dim	-	20000
05426	35W T5 Triphosphor H/E Tube Non Dim - 1449mm	3500K	3300	Non Dim	-	20000
12055	4W - 80W Starter	-	-	-	-	-
12056	4W - 22W Series Starter	-	-	-	-	-
12057	70W - 125W Starter	-	-	-	-	-
12059	4W - 125W Electronic Starter	-	-	-	-	-

All 25 way or 40 way outer boxes are individually bubble wrapped to avoid breakages in transit.

WEEE Registration Number: Wee/GJ0117XV

No Additional Charge on Invoice

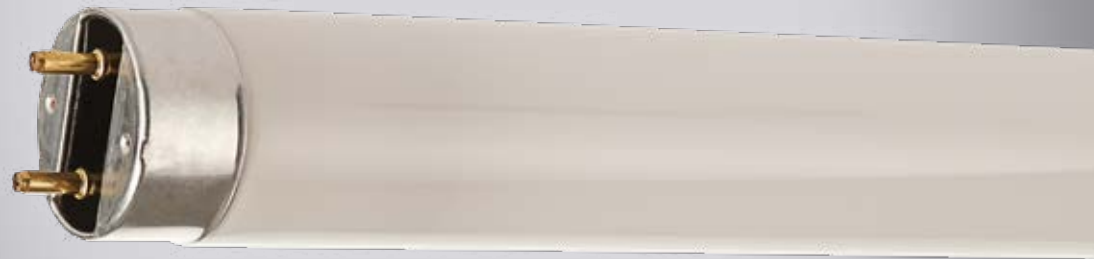

## T5 Triphosphor High Output Tube

Fluorescent Tubes are commonly used in recessed lighting applications. This quality light source offers high lumen maintenance and good colour rendering. This energy efficient lamp offers an impressive 20,000 hour lamp life.

- 20000 Hours

Cool White

Daylight

Tube Ø16mm

Length measurement is from pin end to pin end

Code	Lamp Type	CCT	Lm	Dim	V	Hours
Non Dimmable						
05429	24W T5 Triphosphor H/O Tube - Non Dim, 549mm	6500K	1600	Non Dim	-	20000
05431	39W T5 Triphosphor H/O Tube - Non Dim, 849mm	4000K	3100	Non Dim	-	20000
05435	49W T5 Triphosphor H/O Tube - Non Dim, 1449mm	4000K	4315	Non Dim	-	20000
05436	49W T5 Triphosphor H/O Tube - Non Dim, 1449mm	6500K	4100	Non Dim	-	20000
05440	54W T5 Triphosphor H/O Tube - Non Dim, 1149mm	6500K	4800	Non Dim	-	20000
05443	80W T5 Triphosphor H/O Tube - Non Dim, 1449mm	4000K	6500	Non Dim	-	20000
05444	80W T5 Triphosphor H/O Tube - Non Dim, 1449mm	6500K	6300	Non Dim	-	20000
12055	4W - 80W Starter	-	-	-	-	-
12056	4W - 22W Series Starter	-	-	-	-	-
12057	70W - 125W Starter	-	-	-	-	-
12059	4W - 125W Electronic Starter	-	-	-	-	-

All 25 way or 40 way outer boxes are individually bubble wrapped to avoid breakages in transit.

WEEE Registration Number: Wee/GJ0117XV  
No Additional Charge on Invoice





## T8 Triphosphor Tube

Fluorescent Tubes are commonly used in recessed lighting applications. This quality light source offers high lumen maintenance, energy efficiency and an impressive 20,000 hour lamp life.

- 20000 Hours

Cool White / White / Daylight / Tube Ø16mm / Length measurement is from pin end to pin end

Code	Lamp Type	CCT	Lm	Dim	V	Hours
Non Dimmable						
05447	15W T8 Triphosphor Tube - Non Dim, 451mm	3500K	960	Non Dim	-	20000
05449	15W T8 Triphosphor Tube - Non Dim, 451mm	6500K	900	Non Dim	-	20000
05551	18W T8 Triphosphor Tube - Non Dim, 600mm	3500K	1350	Non Dim	-	20000
05552	18W T8 Triphosphor Tube - Non Dim, 600mm	4000K	1350	Non Dim	-	20000
05556	30W T8 Triphosphor Tube - Non Dim, 900mm	3500K	2400	Non Dim	-	20000
05560	36W T8 Triphosphor Tube - Non Dim, 1200mm	3500K	3350	Non Dim	-	20000
05561	36W T8 Triphosphor Tube - Non Dim, 1200mm	4000K	3350	Non Dim	-	20000
05565	58W T8 Triphosphor Tube - Non Dim, 1500mm	3500K	5220	Non Dim	-	20000
05566	58W T8 Triphosphor Tube - Non Dim, 1500mm	4000K	5220	Non Dim	-	20000
05573	70W T8 Triphosphor Tube - Non Dim, 1800mm	3500K	6300	Non Dim	-	20000
05576	70W T8 Triphosphor Tube - Non Dim, 1800mm	4000K	6300	Non Dim	-	20000
12055	4W - 80W Starter	-	-	-	-	-
12056	4W - 22W Series Starter	-	-	-	-	-
12057	70W - 125W Starter	-	-	-	-	-
12059	4W - 125W Electronic Starter	-	-	-	-	-

All 25 way or 40 way outer boxes are individually bubble wrapped to avoid breakages in transit.

WEEE Registration Number: Wee/GJ0117XV. No Additional Charge on Invoice



## Class 'C' Halogen Capsule LV Capsule UV Block

Our range of Halogen capsules are ideal for all decorative lighting applications. Dimmable as standard and available in a wide variety of wattages.

- 2000 Hours
- Dimmable
- Retro-Fit

Warm White

Code	Lamp Type	CCT	Lm	Dim	V	Hours
Dimmable						
04079	18W E/S G9 Capsule Clear - Dimmable, Class C	2700K	205	Dim	240	2000
04080	28W E/S G9 Capsule Clear - Dimmable, Class C	2700K	370	Dim	240	2000
04081	42W E/S G9 Capsule Clear - Dimmable, Class C	2700K	625	Dim	240	2000
04090	5W Capsule- G4, M9 - Dimmable	2700K	50	Dim	12	2000
04120	10W Capsule- G4, M91 - Dimmable	2700K	120	Dim	12	2000
04100	20W Capsule- G4, M47 - Dimmable	2700K	300	Dim	12	2000
04129	20W Capsule- GY6.35, M76 - Dimmable	2700K	300	Dim	12	2000
04130	35W Capsule- GY6.35, M75 - Dimmable	2700K	600	Dim	12	2000
04110	50W Capsule- GY6.35, M32 - Dimmable	2700K	900	Dim	12	2000





## Class 'C' Energy Saving 78/117mm R7's Linear

Our range of Linear Halogen lamps are ideal for both domestic & commercial applications. Dimmable as standard and available in a wide variety of sizes & wattages.

- 2000 Hours
- Dimmable
- Retro-Fit

Clear

Warm White

Code	Lamp Type	CCT	Lm	Dim	V	Hours
Dimmable						
03841	80W 240V 78mm Halogen Linear - R7 Dimmable	2700K	1400	Dim	240	2000
03842	120W 240V 78mm Halogen Linear - R7 Dimmable	2700K	2250	Dim	240	2000
03847	80W 240V 117mm Halogen Linear - R7 Dimmable	2700K	1400	Dim	240	2000
03843	120W 240V 117mm Halogen Linear - R7 Dimmable	2700K	2250	Dim	240	2000
03844	160W 240V 117mm Halogen Linear - R7 Dimmable	2700K	3150	Dim	240	2000
03845	240W 240V 117mm Halogen Linear - R7 Dimmable	2700K	4900	Dim	240	2000
03846	400W 240V 117mm Halogen Linear - R7 Dimmable	2700K	8700	Dim	240	2000







## Appliance Lamps

Our range of Appliance Lamps cover a wide range of applications for all domestic appliances. Available in multiple wattages and sizes. Dimmable as standard.

- Traditional Lamps
- Dimmable
- 1000 Hours

Clear

Warm White

Microwave/Fridge H 35mm Ø17mm

Cooker Hood H 85mm Ø25mm

Oven Lamp 300° H 50mm Ø22mm

Code	Lamp Type	CCT	Lm	Dim	V	Hours
Dimmable						
02400	15W Appliance Microwave/Fridge Lamp Dimmable SBC Clear	2700K	80	Dim	240	1000
02410	15W Appliance Microwave/Fridge Lamp Dimmable SES Clear	2700K	80	Dim	240	1000
02420	40W Cooker Hood Lamp Dimmable SBC Clear	2700K	360	Dim	240	1000
02430	40W Cooker Hood Lamp Dimmable SES Clear	2700K	360	Dim	240	1000
02431	15W Oven Lamp 300 Degree Dimmable SES Clear	2700K	85	Dim	240	1000
02432	25W Oven Lamp 300 Degree Dimmable SES Clear	2700K	190	Dim	240	1000
02433	40W Oven Lamp 300 Degree Dimmable SES Clear	2700K	360	Dim	240	1000



## Pygmy/Small Sign Night Light

Our Small Sign & Night Light Lamps are available in a variety of wattages and cap types. Dimmable as standard with a Warm White finish.

- Traditional Lamps
- Dimmable
- 1000 Hours

Clear

Warm White

Pygmy H 50mm Ø26mm

Night Light H 49mm Ø20mm

Code	Lamp Type	CCT	Lm	Dim	V	Hours
Dimmable						
02530	15W Small Sign (Pygmy) Dimmable - BC Clear	2700K	90	Dim	240	1000
02610	15W Small Sign (Pygmy) Dimmable - SES Clear	2700K	90	Dim	240	1000
02630	25W Small Sign (Pygmy) Dimmable - BC Clear	2700K	170	Dim	240	1000
02640	25W Small Sign (Pygmy) Dimmable - SBC Clear	2700K	170	Dim	240	1000
02650	25W Small Sign (Pygmy) Dimmable - SES Clear	2700K	170	Dim	240	1000
02393	7W Nightlight Dimmable - CES Clear	2700K	34	Dim	240	1000
02392	7W Nightlight Dimmable - SES Clear	2700K	34	Dim	240	1000



## IP Ratings

Classification of the degree of protection a luminaire provides against the entry of solid foreign bodies and moisture. IP65 rated units are protected against dust and offer protection against water jets.

### Recommended Light Levels - CIBSE Guidelines

Public areas with dark surroundings 10-50 Lux

Car parks 10-50 Lux

Warehouse racking 150 Lux

Brighter areas such as bathrooms 150-200 Lux

Warehouses, homes & theatres 150-200 Lux

Simple office work and classrooms 300-500 Lux

Normal office work with computers 300-500 Lux

Supermarkets and workshops 500-1000 Lux

### Typical Lighting requirements for commercial applications

#### Meeting & boardroom

The main lighting should be focused on the table areas. Allowing control of lighting near screens and displays. Use feature lighting to provide depth and impact.

#### Office area

Allow for flexible use of the space so that desks can be repositioned. Consider using occupancy detection and natural daylight, this will require lighting control. Light emergency escape routes.

#### Reception

The reception area provides the first impression of a business. The main and accent lighting should be varied to provide an interesting environment.

#### Stairwells

Focus on safety ensuring good light levels. Also ensure the emergency requirements for escape are met.

#### Showroom

Focus should be on the products being displayed. Good CRI is important to ensure that colours are displayed correctly, BELL LED lamps have good and consistent CRI. Also consider the reliability of the lighting, a long lamp life is important or the products will become dimly lit over time as lamp performance deteriorates.

#### Exterior

Think about the security requirements and the safe passage of staff and visitors when entering and leaving a building. Good exterior lighting can dramatically improve the look of a building so consider both lighting the area around the building and the elevations of the entrance area and side walls. The correct choice of fittings and colour temperature is important.

#### Making the most of your lighting

Good lighting design recognises the need for depth of view. Both ambient and accent lighting should be used, whilst combining colour temperatures to create a more comfortable working environment.

Ambient lighting is the general lighting within an area and typically contributes 80% of the overall lighting level.

Accent lighting adds interest and depth to a design and should compliment but not conflict with the ambient lighting.

This can include wall washing, the subtle use of colour, up lighting and spotlighting.



## IP Ratings

Ingress	Description	Protection	Short Description
0	Not Protected	0	Not Protected
1	Protection against solid objects greater than 50mm	1	Protected against dripping water
2	Protected against solid objects greater than 12mm	2	Protected against dripping water when tilted up to 15°
3	Protected against solid objects greater than 2.5mm	3	Protected against spraying water
4	Protected against solid objects greater than 2.5mm	4	Protected against splashing water
5	Protected against solid objects greater than 1mm	5	Protected against water jets
6	Dust protected	6	Protected against heavy seas
7	Dust Tight	7	Protected against the effects of immersion
		8	Protected against submersion



## Lighting Glossary - a guide to terms used in lighting

### Wattage (W)

The unit for measuring electrical power. It defines the rate of energy consumption by an electrical device when it is in operation. The energy costs of operating a device is calculated as its wattage times the hours of use. In single phase circuits, it is related to volts and amps by the formula: Volts x amps x PF = Watts (Note for AC circuits PF must be included).

### Lumens (Lm)

A unit of light flow, or luminous flux. The lumen rating of a lamp is a measurement of the total light output of the lamp.

### Light Output Ratio (LOR)

The ratio of the total light output of a luminaire, compared with total lamp light output.

### Lux (Lx)

A unit of illuminance or light falling onto a surface. One lux is equal to one lumen per square meter. Ten lux approximately equals one footcandle.

### Candela (Cd)

Unit of luminous intensity, describing the intensity of a light source in a specific direction.

### Colour Rendering Index (CRI)

A scale of the effect of a light source on the colour appearance of an object compared to its colour appearance under a referenced light source. Expressed on a scale of 1-100, where 100 indicates no colour shift. A low CRI rating suggests the colours of objects will appear unnatural under that particular light source.

### Lumen Maintenance Ratio (LMR)

The proportion of light output of a lamp after a stated period compared with initial lumen output.

### Colour Temperature

The colour temperature is a specification of the colour appearance of a light source, relating the colour to a reference source heated to a particular temperature, measured by the thermal unit Kelvin. The measurement can also be described as the "warmth" or "coolness" of a light source. Generally, sources below 3200K are considered warm, while those above 4000K are considered cool sources.

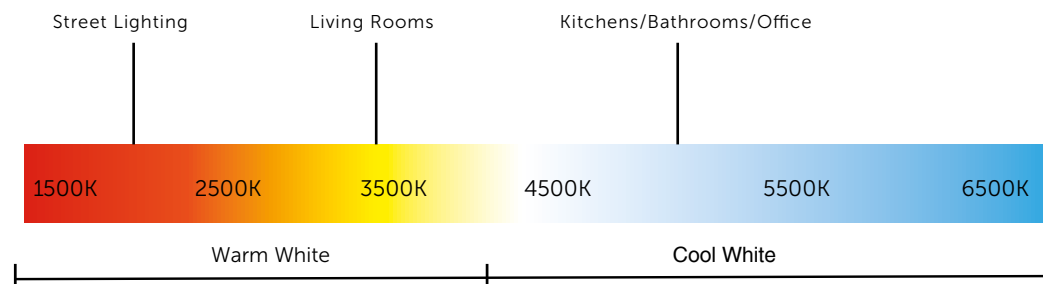

The colour temperature of a light source is measured in degrees Kelvin. Above is a Kelvin temperature chart with examples of how colour temperature is used for different applications.



## Light Pollution What is light pollution?

Most of us are familiar with air, water, and land pollution, but did you know that light can also be a pollutant?

The inappropriate or excessive use of artificial light – known as light pollution – can have serious environmental consequences for humans, wildlife, and our climate. Components of light pollution include:

#### Glare:

Excessive brightness that causes visual discomfort.

#### Skyglow:

Brightening of the night sky over inhabited areas, also known as upward light ratio (ULR).

#### Light trespass:

Light falling where it is not intended.

#### Clutter:

Bright, confusing and excessive light sources.

Light pollution is a side effect of industrial civilization. Its sources include building exterior and interior lighting, advertising, commercial properties, offices, factories, street lights and illuminated sporting venues.

The fact is that much of the outdoor lighting used at night is inefficient, overly bright, poorly targeted, improperly shielded, and, in many cases, completely unnecessary. This light, and the electricity used to create it, is being wasted by spilling it into the sky, rather than focusing it on to the actual objects.

Modern society requires outdoor lighting for a variety of needs, including safety and commerce.

The Institute of Lighting Engineers recognises this but advocates that any required lighting be used wisely. To minimise the harmful effects of light pollution, lighting should:

Only be on when needed / Only light the area that needs it / Be no brighter than necessary / Minimise blue light emissions / Be fully shielded (pointing downward).

The transition from sodium to LED exterior lighting over recent years appears to have made global light pollution worse not better, scientists have reported.

The findings are certain to increase the pressure on the lighting industry to take light pollution seriously and improve the optics and upward light control.

BELL LED Asymmetric Floodlights minimise light pollution.

Skyline Elite Asymmetric floodlights have been designed and developed to meet the strict requirements for a range of sports and area lighting applications.

Specifically designed to control obtrusive light, a precision lensing system ensures a tight beam pattern, reducing overspill upwards light and directing light only where it is needed.

BELL lighting is constantly striving towards reducing light skyglow (ULR), and the Skyline Elite Floodlight is at the forefront of this pollution reducing technology.





## Social Media - Follow our channels

In less than 10 years, social media has become an essential part of our lives, follow BELL Lighting on our channels for all the latest LED lighting news, product updates, special promotions and much more.

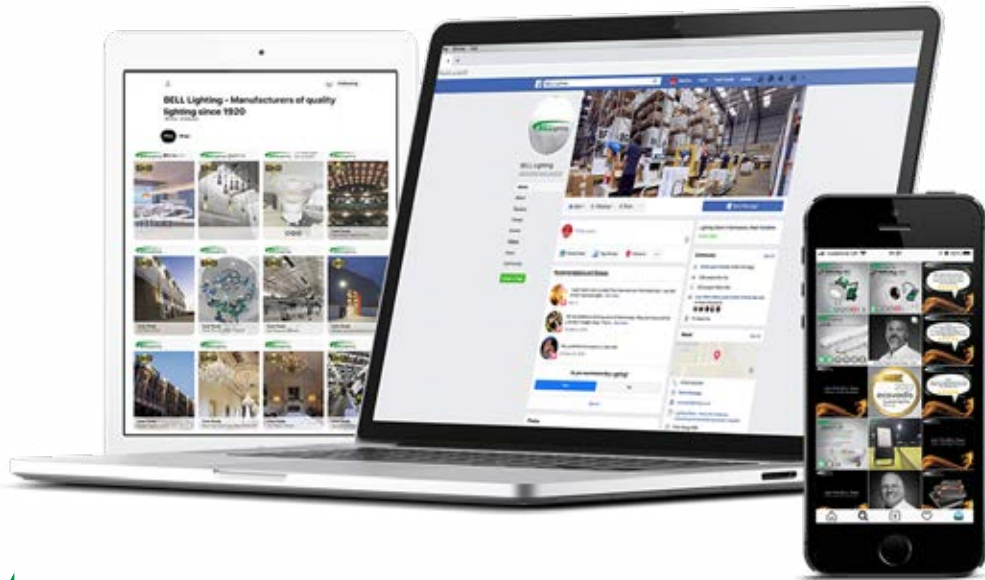

Index



## ELECTRICAL WASTE RECYCLING AND COLLECTION

As customers of Bell Lighting you are able to access our WEEE collection and recycling service.

Our national collection service provides a range of containers collecting the following:



### LAMP RECYCLING



HALOGEN



INCANDESCENT



2D LAMPS



METAL HALIDE



FLUORESCENT



LED LAMPS

### WEEE RECYCLING



GENERAL



SMALL OFFICE



CABLING



KITCHEN



IT OFFICE



LUMINARIES

**BELL CUSTOMERS\*: TO REQUEST A COLLECTION OF OLD PRODUCTS PLEASE CONTACT:**

sales@bellighting.co.uk | 01924 893380 | bellighting.co.uk

**TO REQUEST ANY OTHER RECYCLING PLEASE CONTACT:**

**WERCS** sales@electricalwaste.com | 01388 721 000 | electricalwaste.com  
YOUR COMPLIANCE EXPERTS

\*Collection charges will apply



**Distributed by**

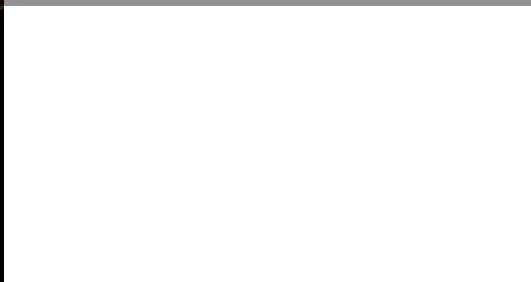

©2024 British Electric Lamps Ltd. No part of this publication may be reproduced, stored in a retrieval system, or transmitted in any form, or by any means, electronic, mechanical, photocopying, recording or otherwise, without the prior permission of the publisher and copyright holder.

E&OE. As it is our policy to continually update our products with the latest in technological advances, the information and images contained in this catalogue are subject to change without notice. All measurements stated are approximate to within production tolerances of +/-5mm.



**British Electric Lamps Ltd**  
BELL House, Foxbridge Way  
Normanton Ind Est, Normanton  
West Yorkshire. WF6 1TN

T: +44 (0)1924 893380  
E: sales@belllighting.co.uk

[www.belllighting.co.uk](http://www.belllighting.co.uk)